UDI™ User Manual

**Protected by patents no. 6125080; 6130859; 6272072
in the US and in other countries**

Version: 1.3

Disclaimers

LIABILITY DISCLAIMER

As is true of every device of diving equipment, including all dive computers, underwater navigation systems and other underwater equipment, the Underwater Digital Interface™ (UDI™) abilities are not limitless. There are certain limitations and restrictions of which you must be aware and certain precautions you must take when using the UDI™. Please read carefully all warnings in this document and disclaimers in each specific chapter of the user manual.

The UDI™ is a computation hardware device combined with software applications that implements a diving computer, digital compass, navigation or tracking after acoustical signals, text messages and alert signal communication. The UDI™ combines all these applications in one unit.

The UDI™ is not a primary device but only an aid to send and receive text messages, to be used as an aid in navigation or tracking after an acoustical signal, as an aid for digital compass and as an aid to send and receive emergency signals. **The UDI™ is not a device of life support gear.** As such, it is unlikely that you will be hurt by the instrument itself any more than you might by a diving computer or any other object of similar shape, size and weight. **The main danger** in the use of UDI™ over-reliance on the information it provides. As an electronic system it might fail spontaneously and unexpectedly due to component, batteries or software failure. As an acoustical device based system, it can fail at any time due to changing environmental (acoustic) conditions.

By purchasing or using the UDI™ system, it is agreed and understood that in no event will Underwater Technologies Center Ltd (UTC) or any of their representatives be held liable for any personal injuries or death or damages to property resulting from its operation, or for any other damages whether direct, indirect, or consequential even if UTC has been advised of such actual or potential damages. UTC products are authorized for use only by certified, recreational divers who have maintained a sufficient level of knowledge and skill proficiency through a combination of formal training, ongoing study and experience. The user must understand that the product is liable to sudden failure.

Underwater operations are inherently dangerous, and proper safety procedures demand that **you never rely solely on just the UDI™** or any other single instrument, method or mechanism for human safety or the safety of property.

REMEMBER - YOU ARE RESPONSIBLE FOR YOUR OWN SAFETY.

DIVING COMPUTER DISCLAIMER

As you probably know and it is true for every device of diving equipment, including all dive computers, underwater and other underwater equipment, the Underwater Digital Interface™ (UDI™) abilities are not limitless. There are certain limitations and restrictions of which you must be aware and certain precautions you must take when using the UDI™ as a diving computer. Please read carefully all warnings in this chapter and this disclaimer.

The UDI™ is a computation hardware device combined with software ("**SOFTWARE**") applications. The diving computer is implemented with software and sensors (such as depth sensor and related electronic components). The UDI™ uses the Reduce Gradient Bubble Model, an algorithm that was developed by Dr. Bruce Wienke from the Los Alamos Institute (United States); the algorithm is used by other diving computers too.

The UDI™ is not a primary device but only an aid to calculate along the dive the time and depth and to suggest how your planned dive meets the actual dive. **The UDI™ is not a device of life support gear and should be used as such device.**

Gauge Mode - The UDI™ enables the diver to disable the diving computer and to use it as a communicator and navigation based on its internal compass. Nevertheless, time and depth are presented on the screen only for assistance, thus the diver should take in considerations that he/she must use a diving computer or diving tables. When the RGBM diving computer is again enabled, the diver must ensure that he/she did not dive for the last 24 hours (otherwise the calculations and the presented figures are wrong and might cause severe results such as injuries or death).

The main danger in the use of UDI™ is over reliance on the information provided by it. As lies in an electronic system it might fail spontaneously and unexpectedly due to component, batteries, incorrect charging or software failure. In addition the UDI™ also contains acoustical functions; hence, as an acoustical device, it can fail at any time due to changing environmental (acoustic) conditions.

By purchasing or using the UDI™ system, it is agreed and understood that in no event will Underwater Technologies Center Ltd (UTC) or any of their representatives be held liable for any personal injuries or death or damages to property resulting from its operation, or for any other damages whether direct, indirect, or consequential even if UTC has been advised of such actual or potential damages. UTC products are authorized for use only by certified, recreational divers who have maintained a sufficient level of knowledge and skill proficiency through a combination of formal training, ongoing study and experience. The user must understand that the product is liable to sudden failure.

THE SPECIFICATIONS AND INFORMATION REGARDING THE DIVING COMPUTER IN THIS MANUAL ARE SUBJECT TO CHANGE WITHOUT NOTICE. ALL STATEMENTS, INFORMATION, AND RECOMMENDATIONS IN THIS MANUAL ARE BELIEVED TO BE ACCURATE BUT ARE PRESENTED WITHOUT WARRANTY OF ANY KIND, EXPRESS OR IMPLIED. USERS MUST TAKE FULL RESPONSIBILITY FOR THEIR APPLICATION OF ANY PRODUCT.

NOTWITHSTANDING ANY OTHER WARRANTY HEREIN, ALL DOCUMENT FILES AND **SOFTWARE OF UTC** ARE PROVIDED "AS IS" WITH ALL FAULTS. **UTC** DISCLAIMS ALL WARRANTIES, EXPRESSED OR IMPLIED, INCLUDING, WITHOUT LIMITATION, THOSE OF MERCHANTABILITY, FITNESS FOR A PARTICULAR PURPOSE AND NON-INFRINGEMENT OR ARISING FROM A COURSE OF DEALING, USAGE, OR TRADE PRACTICE. IN NO EVENT SHALL UTC BE LIABLE FOR ANY DIRECT OR INDIRECT, SPECIAL, CONSEQUENTIAL, OR INCIDENTAL DAMAGES, INJURY, DEATH, INCLUDING, WITHOUT LIMITATION, LOST PROFITS OR LOSS OR DAMAGE TO DATA ARISING OUT OF THE USE OR INABILITY TO USE THIS DIVING COMPUTER, EVEN IF UTC HAS BEEN ADVISED OF THE POSSIBILITY OF SUCH DAMAGES.

Underwater operations are inherently dangerous, and proper safety procedures demand that **you never rely solely on just the UDI™** or any other single instrument, method or mechanism for human safety or the safety of property.

BATTERIES DISCLAIMER

Lithium Ion Batteries can catch on fire. The UDI™ uses Lithium Ion batteries; therefore it should NOT be left unattended while being charged as THEY CAN CATCH ON FIRE. Proper precautions should be taken before charging Lithium ion batteries such as having a fire extinguisher ready and placing the batteries in a fire safe container.

THE UDI™ IS NOT A TOY AND SHOULD BE HANDLED WITH GREAT CARE.

Lithium Polymer Charging, Handling, Safety Information

Charging:

Lithium Polymer and Lithium Ion batteries have specific charging requirements and ONLY the chargers rated for these cells may be used. The best charger for the UDI™ is provided in the pack that you purchased. Other chargers may alter the settings and can damage cells or cause a fire due to over-voltage charging of cells. We recommend that you use only the charger that was provided with the UDI.

Lithium Polymer Lithium Ion cells are a tremendous advance in battery technology for electronic devices. However, due to the chemistry of lithium cells, there is a possibility of fire if charging is not properly done. It is unavoidable due to the nature of lithium itself. This is no different from many things we use in daily life – knives, kitchen cleaners, automobiles, for a few examples – which are inherently dangerous, but which can be used very safely by adhering to simple rules and precautions.

Care should be taken to charge on a fireproof surface, such as brick or in a hot (warm) environment.

Do not charge the UDI™ when lying on an ignitable surface.

If you left the UDI™ in a warm environment or open to sun light, DO NOT CHARGE IT, wait until it will be cooled to a temperature of less than 30 centigrade.

Do not charge batteries near flammable items or liquids

Keep a dry fire extinguisher nearby - or a large bucket of dry sand, which is a cheap and effective extinguisher.

Do not charge inside an automobile, especially while driving.

The UDI™ should NEVER be left unattended while charging.

Handling Cautions:

New cells may have a high initial charge, and care must always be taken to insure that the cap of the UDI™ is completely sealed. DO NOT REPLACE BATTERIES. If the batteries performances are low, please send it to the authorized dealer for repair or replacement.

Charging cycles:

The Batteries should work in good condition for approximately 300 charging cycles. We strongly recommend that every year you'll send the UDI™ for batteries test in order to measure their stability and charging cycles. Please remember, every charging cycle shorten the batteries lifetime and there is an ageing process with the Lithium chemistry, thus, it is important to safely dive with batteries that will enable you to complete the dive.

COMPASS DISCLAIMER

The UDI contains 3-D Magneto Impedance sensor. Combined with software, it generates the North magnetic direction. Common sense must be used at all times when navigating, therefore it should only be considered as aids to navigation. The UTC' policy of continuous improvement may result in changes to product specification without prior notice. It is advised to visit www.utc-digital.com from time to time and to download updates for new algorithm and compensation factors for this sensor.

This compass is intended for recreational dive use only, It should not be used for industrial or professional measurements. The compass' accuracy is highly dependent on the environment, for example, soft or hard metal will highly alter the real measurement. Thus, it is advised not to use the compass in the vicinity of any metals. UTC does not assume any responsibility for losses or claims by third parties that might arise through the use of this compass.

License to use the Software

Notwithstanding anything herein to the contrary, the purchaser and/or user of the UDI™ system shall not obtain any intellectual property right in any the UDI™ system or any part thereof, other than the limited right to use it. The purchaser and/or user of the UDI™ system shall not have, and shall not acquire, in any way, any intellectual property right in the UDI™ system. The UDI™ system shall not be deemed to have been produced as work for hire and any intellectual property right with respect thereto shall remain exclusively with UTC. For the purpose hereof, intellectual property includes, inter alia, any property in and rights under copyright, patents, conceptual solutions and inventions (whether patentable or not), circuit layout rights, design rights, designs, database rights, trade names, trademarks, service marks, methodologies, ideas, processes, methods, tools and know-how, and/or any other types of intellectual property rights. The purchaser and/or user of the UDI™ system may not and shall not permit, abet or aid others to translate, reverse engineer, decompile, disassemble, update or modify all or any part of the UDI™ system.

Contents

UDI™ User Manual	1
Protected by patents no. 6125080; 6130859; 6272072 in the US and in other countries	1
Version: 1.3 Disclaimers	1
Disclaimers.....	2
LIABILITY DISCLAIMER	2
DIVING COMPUTER DISCLAIMER	2
BATTERIES DISCLAIMER	3
Lithium Polymer Charging, Handling, Safety Information	4
Charging:.....	4
Handling Cautions:	4
Charging cycles:	4
COMPASS DISCLAIMER.....	4
License to use the Software	5
Contents	6
Introduction	8
Safety	9
Battery saving and water sensor.....	9
Before every dive	9
UDI™ unit.....	10
Unit Description	10
Using the quick connector.....	11
Charging the UDI	11
Connecting the UDI™ to the PC.....	12
Using the UDI	13
Turning UDI™ On and Off.....	13
Scrolling the menus.....	13
UDI™ main menu	14
Setting up the UDI™	15
Gauge mode.....	16
Enable/Disable Gauge mode	16
RGBM Setup	18
Entering/Exiting RGBM Setup mode.....	18
Water	19
Altitude.....	19
Nitrox.....	19
RGBM Model	19
Deep stops.....	20
Dive Plan	21
New diver	21
PC Connection	22
List Sync	23
Network Setup.....	24
UDI™ Setup	25
Clock.....	25
Audio	25
Backlight.....	25
LED Control.....	26
LCD Contrast.....	26
Units	26
About UDI.....	26
Revert to factory settings:	26
Using the Dive Computer	27
Surface display	27
Underwater display.....	27
Dive computer parameters.....	28
Reviewing RGBM setup and viewing additional data	28
Abnormal conditions.....	30

Low battery prior to a dive	30
Low battery during dive	30
Empty battery during dive	30
Fast ascent	31
Safety stop and Deco stop violation.....	31
Severe decompression violation	31
Using the Compass.....	31
Sending and receiving text messages	32
Sending a message.....	32
Viewing last message.....	33
Receiving a message.....	33
Navigation to a target.....	34
Navigation mode and method	35
Using the Navigation display.....	35
SOS Signals	37
Remote homing.....	37
Remote SOS.....	38
Mask Homing	38
Care and maintenance.....	39
Revert to factory setting	39
Base [boat] unit.....	40
Charging the UDI™ boat unit	41
Connecting the UDI™ boat unit to the PC.....	41
Turning UDI™ boat unit On and Off.....	42
Scrolling the menus.....	42
UDI™ Boat unit main menu.....	42
Sending and receiving text messages.....	42
Sending a message.....	43
Viewing last message.....	43
Receiving a message.....	44
Using the Compass.....	44
SOS Signals	45
Remote homing/Remote SOS.....	45
Setting up the UDI Boat Unit.....	46
List Sync	47
UDI Boat unit setup.....	47
Clock.....	47
Audio	48
Backlight.....	48
LED Control.....	48
LCD Contrast.....	48
Units	49
About UDI.....	49
Care and maintenance.....	49
Revert to factory setting:.....	49
DiveSim™ software.....	50
Using the software	50
PC Simulator	52
UDI™ Simulator	53
Database function	54
Manage UDI™ log	56
Update your UDI.....	57
Appendix – RGBM Model.....	60

Introduction

Congratulations on your purchase of the UTC – Underwater Digital Interface (UDI) System. UDI™ is a device that contains several functions used for diver safety, communication and computation.

To active your warranty and allow us to update your UDI™ software from time to time, please visit our web site www.utc-digital.com and fill the online registration card.

The system consists of the UDI™ diving unit, an optional UDI™ boat station, and the DiveSim software.

The UDI™ and optional boat unit contain the following functions:

- Text messages communication device
- SOS signal transmission and reception
- Navigation unit and homing device
- Dive computer (on the dive unit only)
- Compass

The DiveSim PC software can be used in conjunction with the UDI™ to plan dives, review dive data, and simulate dives. The software can also be used to update text message lists and other housekeeping functions. The DiveSim is used also to manage dive log files.

The UDI™ text messaging system links divers through transmission of pre-set messages with ease and reliability at ranges of up to 500 meters, depending on environmental conditions.

Upon receiving a message signal, the UDI™ unit sounds an audible alert and lights up to show the message.

The SOS signal can be activated by a diver in distress, or remotely by any diver who suspects that his buddy is in distress. Upon activation of an SOS signal, the UDI™ transmits information needed to locate the SOS sender.

Each UDI™ includes a homing device to help the diver locate other divers or the dive boat.

The UDI™ can be worn on the lower arm or attached to the Buoyancy Compensator (BC).

The UDI™ permits a diver to communicate with any other diver on the network without distractions or potential discomforts and expense of voice communications gear.

Safety

Read and understand this user guide prior to using the UDI.

Pay close attention to all cautions and warnings listed. Make sure that you fully understand the use, displays and limitations of the UDI™ prior to diving. Improper use of this device may cause a diver to commit actions that could lead to serious injury or death.



WARNING: The UDI™ must never be traded or shared between users while it is in operation. Switching the UDI™ to a new diver using this feature will void any data from the previous diver.

Ensure that the new diver has not dived in the previous 24 hours prior to using the UDI™ – the computer cannot account for dives performed without the UDI.

Battery saving and water sensor

The UDI™ has a battery saving mode. After the UDI™ unit is turned on:

- If no button is pressed on the UDI™ or 10 minutes, the UDI™ goes to standby, and the screen displays the word Standby.
- After 60 minutes of no activity, the UDI™ turns off.

The UDI™ unit contains a water sensor. When the UDI™ unit that has been turned on or is in standby comes in contact with water, the dive computer becomes activated.

A dive calculation starts when the UDI™ reaches a depth of 2 meters, and is wet for at least 15 seconds.

Before every dive

To ensure your safe use of the UDI™ before every dive, you must check:

- UDI™ battery is charged
- The RGBM settings and diving computer settings are set to match the planned dive conditions
- The list of names (users) in the dive group
- The network used between you and your buddy or group.
- Check communications by sending a message to your buddy and receiving a message back.

UDI™ unit

Unit Description

The UDI™ unit consists of the following:

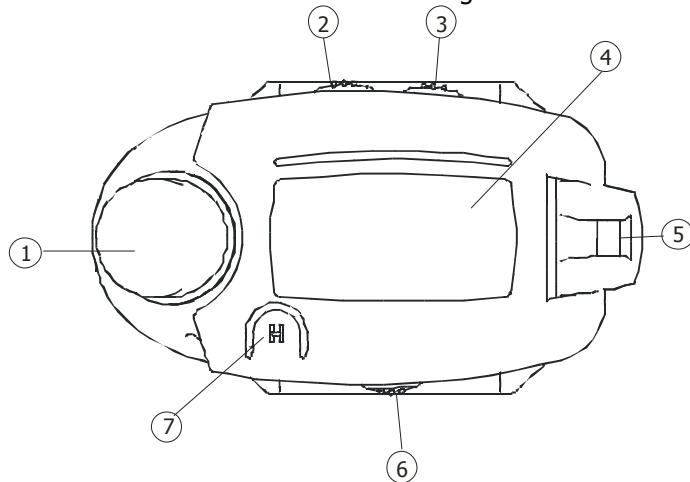

- | | |
|-----------------------|-----------------------------------|
| 1. Antenna | 4. LCD display, plastic protector |
| 2. Up scroll button | 5. Attachment buckle |
| 3. Down scroll button | 6. Enter button |
| | 7. Emergency (SOS) button |

The UDI™ contains the following functions:

- Dive computer
- Electronic compass
- Message sending/receiving
- Homing device
- Emergency beacon
- Dive logger

Use of these functions is explained below.

Using the quick connector

A quick connector is used connect the UDI™ unit to a power supply or to a PC.

Attach the quick connector to the UDI™ as show below, ensure the contacts are dry.

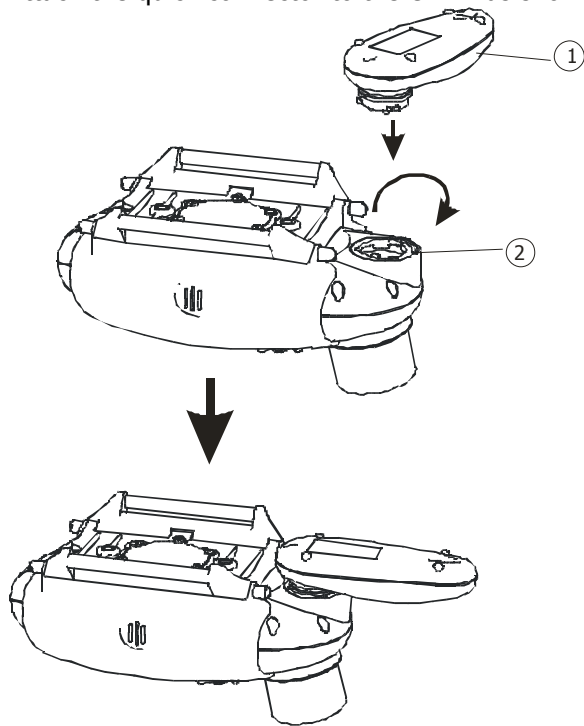

1. Quick Connector

2. Connector bracket on UDI

Charging the UDI

UDI™ uses a rechargeable internal Li battery. This battery can be recharged only with the UDI™ charger.



NOTE: Read *Lithium Polymer Charging, Handling, Safety Information* on page 4.



WARNING: The UDI™ is a completely sealed unit. It may stop functioning if opened. The warranty will be void if the unit is disassembled or the seal is broken.

Ensure that the UDI™ is fully charged before your dive.

Charge the battery for 12 hours prior to the first time you use the UDI.

To charge the UDI:

Ensure that your hands, the UDI™ and the charger are dry!

Connect the quick adapter to the UDI

1. Connect the power charger to the quick connector.
2. Connect the power charger to a power supply. The green LED will turn on.

The charge is complete when the green light on the quick connector turns off.



NOTE: A steady or flashing red LED indicates a problem with the charger or the battery. Disconnect the charger and repeat steps 2 to 4. If this does not resolve the problem, return the unit for service

Connecting the UDI™ to the PC

You can connect the UDI™ to the PC to perform data transfers, and dive simulations using the DiveSim application. See page 50 for information on using DiveSim.

To connect the UDI™ to the PC:

1. Connect the quick connector to the UDI
 2. Connect the USB cable to the quick connector.
 3. Connect the USB cable to the computer.
-



NOTE: Ensure that you have properly installed the DiveSim software to be able to use this function.

To activate the connection to the PC, you must enable this option on the UDI. See page 22

Using the UDI

Turning UDI™ On and Off

To turn the UDI™ on:

1. Press and hold the **Enter** button for about 5 seconds. The UTC Proprietary screen opens. (if pushing the Enter button for a short time, a message on the screen will appear mentioning the need for a longer push)



NOTE: The UTC Proprietary screen contains a disclaimer. Clicking on the **Enter** button signifies that you accept responsibility for use of the UDI, and that you accept the terms of the disclaimer. If you do not agree, please do not dive with the UDI™.

2. Press the **Enter** button again. The current settings screen opens.
3. Press the **Enter** button again. The setup menu opens. After a few seconds, the dive computer displays.

Standby mode:

- The UDI™ unit goes into Standby mode after 10 minutes of inactivity on the surface.
- The UDI™ unit goes from Standby to Off after 1 hour of inactivity on the surface.
- When in Standby mode, the UDI™ unit instantly returns to use upon contact with water, or when a button is pushed for 2 seconds.

To turn UDI™ off:

Press and hold the **Enter** button for about 4-6 seconds. The UDI™ turns off.



WARNING: Power **cannot** be turned off during a dive.

Scrolling the menus

To scroll through the menu options, press the **Up** or **Down** buttons.

To select an option, press the **Enter** button.

UDI™ main menu

The main UDI™ menu allows you to access UDI™ functions. The main menu flowchart is shown below.

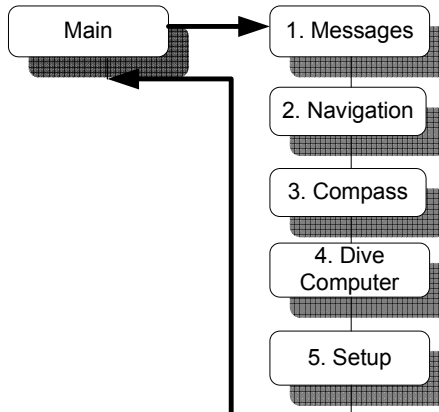

Use of the various functions is described in detail as follows:

- Setup – see page 15
- Dive computer – see page 27
- Messages – see page 32
- Navigation – see page 34
- Compass – see page 31

Setting up the UDI™

Use the Setup menu to set up the UDI™ for the following features:

- Gauge mode – Enable/Disable the Gauge mode option
- RGBM Setup – Setup features of the RGBM model for use with the dive computer.
- PC Connection – Connect to a PC for use with the DiveSim software.
- List Sync. – Synchronize message and user lists with other UDI™ units.
- Network Setup– Set network for communication with buddy.
- UDI™ Setup – Set UDI™ parameters – clock, audio, light, units etc.
- Main – Returns you to the Main menu.

The Setup menu flowchart is shown below.

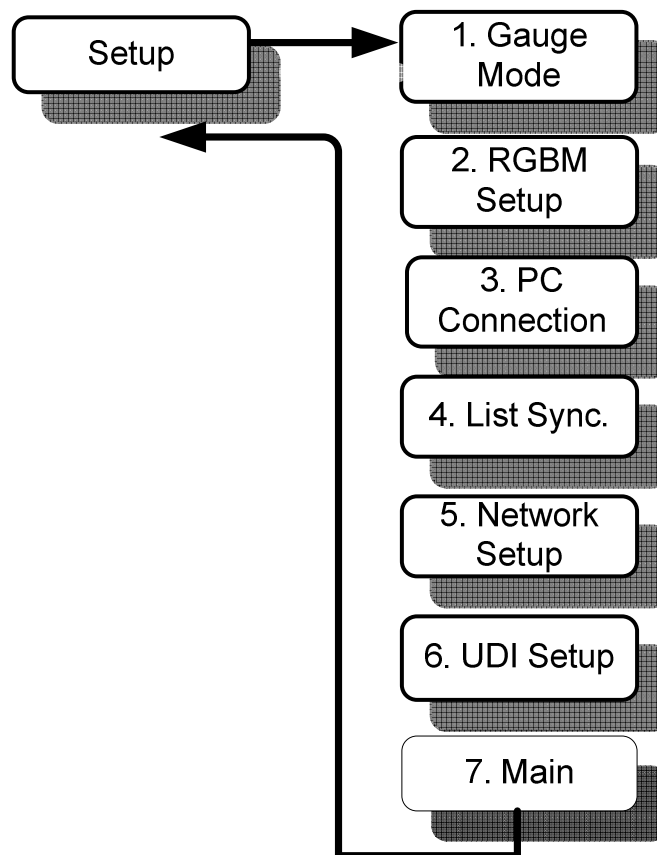

To enter the Setup menu:

1. From the Dive computer display, double-click **Enter**. The **Main** menu opens.
2. Use the **Up/Down** buttons to scroll to Setup.
3. Press **Enter**.

To exit the **Setup** menu and return to the **Main** menu, select **Main**, and press **Enter**.

Gauge mode



NOTE: User must be aware that in this mode of operation, alerts related to the diving computer will NOT be provided.



WARNING: When the UDI™ works in gauge mode, it only measures the time and depth and doesn't function as a diving computer that calculates the Nitrogen levels. In addition, it doesn't provide any alerts. Enable again the dive computer; will result "New Diver", thus the diver MUST be aware that the diving computer has no information with respect to the last 24 hours. The UDI™'s algorithm assumes no dive for the last 24 hours.

If this condition is not accurate and the diver dove in the last 24 hours, **DO NOT USE** the UDI or **DO NOT** trust the presented figures.

Enable/Disable Gauge mode

To enable the Gauge mode:

1. From the **Main** menu, select **Setup** and press **Enter**.
2. From the **Setup** menu, select **Gauge mode** and press **Enter**.

Select Enable and press **Enter**
The default: Disable

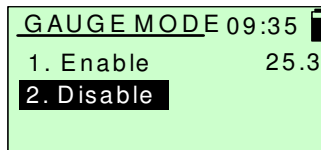

If the UDI was **not** in a Gauge mode and you choose the "Enable" option, the following disclaimer will be presented

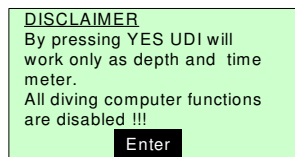

The next step requires an approval:

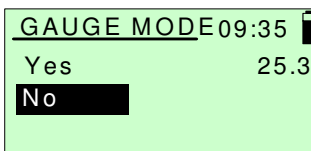

In Gauge mode, the Dive computer presents the following screen:

Depth 20	dive time 25 
Dmax 21	
124°	GAUGE MODE

In a Gauge mode, there are two shortcuts: pressing "Down" button will show for 10 seconds the compass, pressing the "Up" button direct the user to the main menu

To disable the Gauge mode:

1. From the **Main** menu, select **Setup** and press **Enter**.
2. From the **Setup** menu, select **Gauge mode** and press **Enter**.

Select Disable and press **Enter**
The default: Disable

GAUGE MODE 09:35 	
1. Enable	25.3
2. Disable	

Changing from Gauge mode, the UDI™ will be set as "New Diver" (read further implications in New Diver paragraph of the RGBM setup in the next pages).

1. The Disclaimer appears. Click **Enter**.
2. Select **Yes** for a New Diver and press **Enter**. The UDI™ is set as New Diver

DISCLAIMER
By selecting YES, you certify that the diver that intends to use this device has not dove in the last 24 hours.
ENTER
NEW DIVER
Yes
No

If Gauge mode was Disabled, the Diving computer presents the following screen:

Depth: 15.4	Dive Time: 25
Dmax: 32.0	
124°	No Deco: 4



NOTE: UTC strongly advises that the Dive computer will be in an "Enable" in any dive.

RGBM Setup

Use the RGBM Setup options to set the features of the RGBM model for use with the dive computer.

The RGBM Setup flowchart is shown below.

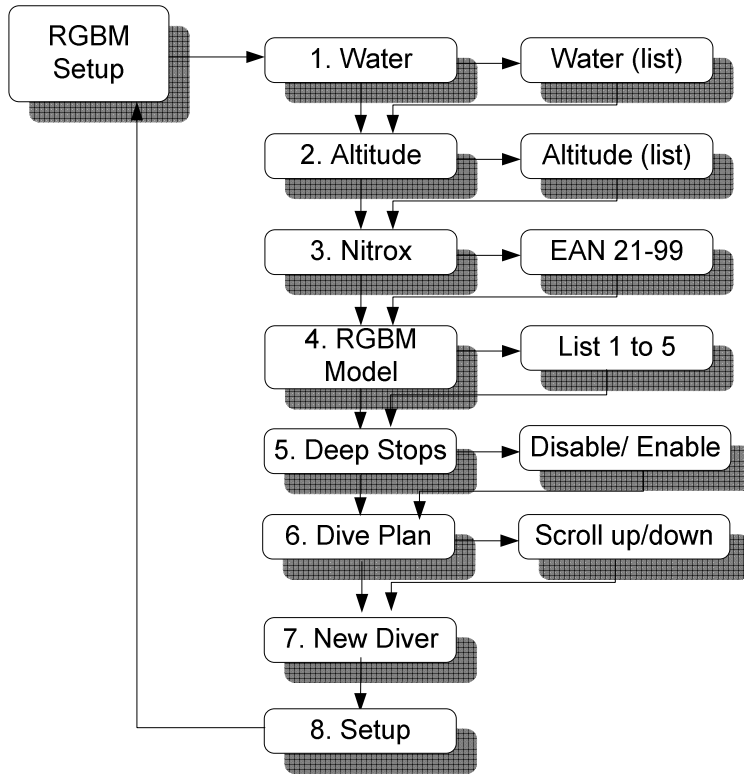

Entering/Exiting RGBM Setup mode

To enter RGBM Setup mode:

1. From the **Main** menu, select **Setup** and press **Enter**.
2. From the **Setup** menu, select **RGBM Setup** and press **Enter**.

To exit RGBM Setup mode:

Use the **Up/ Down** buttons to scroll to **SETUP**, and press **Enter** this automatically saves all parameters and configurations that you defined.

The saved parameters will be used as the default settings until such time that you modify them again.

Water

Select the water environment:
Salt or **Fresh** water and press
Enter

The default: Salt

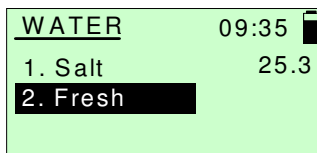

Altitude

The UTC RGBM model can be adjusted for high altitude dives where water bodies are above sea level. Select the altitude group from four groups:

- 0 – 700 meters.
- 700 – 1500 meters.
- 1500 – 2400 meters.
- 2400 – 3700 meters.

Note: The display will be in meters or feet, depending on your UDI™ setup. See page 26.

Select altitude group that matches your starting dive conditions and press **Enter**.

The default: 0-700m

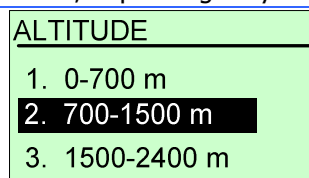

Nitrox

Set the gas mixture NITROX - can be set between EAN21 (air- 21% Oxygen) to EAN99 (99% Oxygen).

Use the **Up/Down** buttons to change the EAN value from EAN 21 (air) to EAN 99 and press **Enter**.

The default: Air (21%)

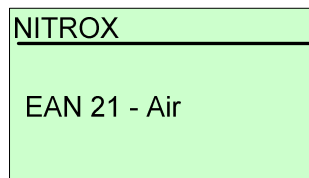

RGBM Model

Select the conservatism of the mathematical Nitrogen model. (See Appendix A – RGBM model for information).

There are five conservative levels:

- Model 4 - $PPO_2 < 1.40$ ATM - Most conservative
- Model 3 - $PPO_2 = 1.45$ ATM
- Model 2 - $PPO_2 = 1.50$ ATM - Recommended
- Model 1 - $PPO_2 = 1.55$ ATM
- Model 0 - $PPO_2 = 1.60$ ATM - Least conservative



NOTE: UTC strongly advises the default use of **Model 2** which gives full RGBM effect.

The dive model level considers several factors that may affect susceptibility of a diver to decompression illness. These factors vary between divers, for the same diver from one day to the next; and are also highly dependent on the health conditions of each diver.

UTC had not developed a decompression calculation model. We are licensed to use the RGBM model as was defined and developed by Dr. Bruce Wienke. In no case UTC will be liable to any damage of phenomena related to decompression thickness

The 5-step dive model allows you to set your personal adjustment mode. Some of the personal factors that could affect susceptibility of a diver to decompression illness include:

- Cold water – temperature less than 20°C (68 °F)
- Physical fitness level
- Fatigue
- Hydration level
- Stress
- Obesity
- Previous history of decompression illness

Select the appropriate model and press **Enter**

The default: Model 2

RGBM MODEL
1. Model 1
2. Model 2
3. Model 3

Deep stops

Deep Stops are decompression stops that occur deeper than the traditional safety stop, with the purpose of minimizing micro bubble formation and excitation.

You can choose the RGBM deep stop algorithm in addition to the traditional recommended safety stop.

Traditionally, for every dive deeper than 8 meters (26 feet), the diver should make a safety stop for 3 minutes between 3-6 meters (9-19 feet).

The RGBM model calculates deep stop iteratively, placing the first stop about halfway between the maximum depth and the ceiling depth. After the first deep stop is completed, another deep stop will be prompted halfway to the ceiling and so on when the last deep stop is placed at 5 meters (17 feet) for 2 minutes.

The duration of each deep stop is increased by one minute from one deep stop to another, with the first deep stop duration being one minute.

When you enable Deep Stops, the traditional recommended safety stop is applied for a dive of less than 30 meters (98 feet). For dives deeper than 30 meters (98 feet), the Deep Stop algorithm is applied in addition to the traditionally safety stop.



NOTE: Deep Stops improve the diver safety. While ignoring these stops will not result in penalty during repetitive dives we strongly recommend that the diver use these stops.

Select to **Enable** or **Disable** deep stops and press **Enter**.

The default: Enable

DEEP STOPS
1. Enable
2. Disable

Dive Plan

The **Dive Plan** shows the calculated **no-decompression time** at the selected depth and the **maximum depth** related to PPO₂ toxicity, based on the RGBM settings selected, and current Nitrogen partial pressure for the diver, taking into account the previous dives performed.

Use the **Up/Down** buttons to change the depth in steps of 3 meters.
Press **Enter** to return to the RGBM setup menu.

DIVE PLAN
Depth: 58
Time: 45
PO2 Depth: 19

New diver

Switch the UDI™ between divers by resetting the diving computer. This requires confirmation of the diver to the disclaimer.



WARNING: The UDI™ must never be traded or shared between users while it is in operation. Switching the UDI™ to a new diver using this feature will void any data from the previous diver. Ensure that the new diver has not dived in the previous 24 hours prior to using the UDI™ – the computer cannot account for dives performed without the UDI.
Ignoring this warning may result in serious injury or death!!!

3. The Disclaimer appears. Click **Enter**.
4. Select **Yes** for a New Diver and press **Enter**. The UDI™ is set for a new diver

DISCLAIMER
By selecting YES, you certify that the diver that intends to use this device has not dove in the last 24 hours.
ENTER

NEW DIVER
Yes
No

PC Connection

Use the PC Connection option to connect UDI™ to your PC and use it with the DiveSim™ application. See page 50 for information on using DiveSim™.



WARNING: Do not enter the water with the UDI™ when the “PC connection” is active. This will damage your UDI.



NOTE: When the PC connection has not been used for 2 minutes, it becomes disabled to prevent any damage to the UDI™ in case you forget to disable the PC connection option.

To use PC Connection:

1. Connect the quick connector to the UDI
2. Connect the USB cable to the quick connector.
3. Connect the USB cable to the PC computer.
4. On the UDI™ **Setup** menu, select **PC Connection**.
5. Select **Enable** press **Enter** to enable the PC Connection. A **PC** indication appears at the bottom right corner of the display while the UDI™ is connected to the PC.

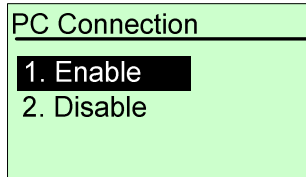

NOTE: Communication with the UDI™ is done using the DiveSim™ software provided with your system. See DiveSim™ software on page 50 for details.

List Sync

Use this option to synchronize the users list and messages list with other UDI™ users in the group.

1. Place the UDI™ units with the antennas touching or as close as possible to each other.
2. In the Setup menu of each unit, select List Sync and press **Enter**.

3. Select **UDI™ Status** and press **Enter**. The UDI™ Status menu opens.

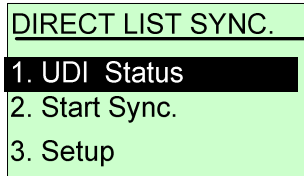

4. Select whether your UDI™ will be sending synch data or receiving synch data and press **Enter**.

- Set the receiving UDI™ unit to **Receiving**.
- Then set the sending unit to **Sending**.

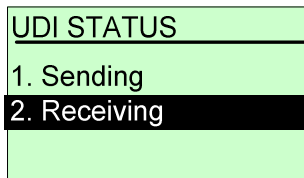

5. In the Direct List Sync. menu, select **Start Sync.** to start the synchronization process. Always make sure the receiving device is started the first.

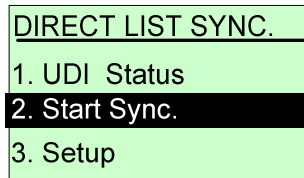

6. Press **Enter**. The display shows **Updating...**
7. When the update is complete, the display reverts to the Direct List Sync menu.

In case of a possible failure in the communication, the cycle will repeat automatically – till the receiving UDI™ will prompt "Copy succeeds".



NOTE: If the synchronization fails, restart the process from Step 3.

Network Setup

Use this option to select User and Buddy numbers; and a network.



NOTE: You and your buddy must be properly defined on your UDI™ and your buddy's UDI™ respectively, and you must both be on the same network to be able to communicate using the UDI.

1. Select **Net** to define a network to use, and press **Enter**.

NETWORK SETTING
4. Setup
1. Net
2. User

2. Select a network from 1 to 4, and press **Enter**.

NETWORK
4. Net 4
1. Net 1
2. Net 2

3. Select **User** to define the user name/number for the UDI™ and press **Enter**.

NETWORK SETTING
1. Net
2. User
3. Buddy

4. Select a User (named or numbered) from the 14 users, and press **Enter**.

USER
1. User 1
2. Brad
3. Jen

5. Select **Buddy** to define your buddy number and press **Enter**.

NETWORK SETTING
2. User
3. Buddy
4. Setup

6. Select a User (named or numbered) from the 14 individual users, boat, or all users and press **Enter**. This will be your default for sending a message to.

BUDDY
3. Jen
4. Bob
5. Armin

UDI™ Setup

Use the UDI™ Setup menu options to set the time, ring volume, light and units on your UDI.

Clock

Use this option to set the time and date.

1. Press **Enter** to select a time unit.
2. Use the **Up/Down** buttons to set the appropriate value.
3. Press **Enter** to move to the next time unit on the list.
4. Repeat.
5. When you have set the year value, press **Enter** to return to the **UDI™ Setup** menu.

CLOCK SETUP	
Minute:	11
Hour:	16
Date:	3
Month:	8
Year:	2007

Audio

Use this option to select an audio alert volume. Audio alerts sound to get your attention to the dive computer under various events during a dive.

There are four levels of alert:

- High
- Med-High
- Med
- Low

Select a ring level and press **Enter**

AUDIO
1 High
2 Med-High
3 Med

Backlight

Use this option to select the time until the UDI™ backlight turns off. Shutoff interval of 5 seconds range from 0 (off) to 55 seconds, and INF (infinite) when the backlight remains constantly lit.



NOTE: Extended use of the light may reduce battery time between charges.

Use the **Up/Down** buttons to define a time value and press **Enter**.

BACKLIGHT TIMER
Timer - 10 sec.

LED Control

Use this option to turn on or off the LED control which allows the LED on the UDI™ to blink when there is an audible alarm or when a signal is received.

Select Enable or Disable and press **Enter**.

The Default: Enable

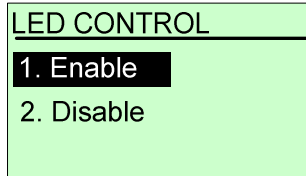

LCD Contrast

Use this option to select a contrast level for the LCD display. .
The contrast interval ranges from 1 (very little contrast) to 7 (high contrast).

Use the **Up/Down** buttons to define a contrast value and press **Enter**. Make sure there are no strips seen on the screen.

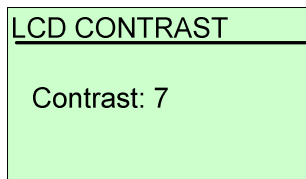

Units

Use this option to select Metric units (meters, degrees C) or Imperial units (Feet, degrees F) as your unit of measurement.

Select Imperial or Metric and press **Enter**. All units displayed on the UDI™ will now conform to the unit type chosen.

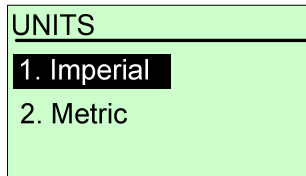

NOTE: The temperature displays according to your units selection – When you select Feet, Fahrenheit degrees are shown, when you select Meters, centigrade degrees are shown.

About UDI

Use this option to view the UDI™ serial number and software version installed. Use this information when contacting UTC about your UDI.

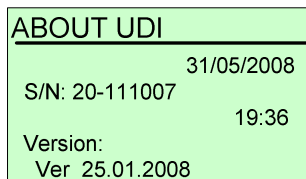

Revert to factory settings:

In case you would like to revert to the original UDI™ factory settings, press the **Up**, **Down** and **Enter** buttons simultaneously to start the UDI™ on. Wait for the UDI to turn on and for the message "set default" appears on the screen. All customizations and settings you have done will be erased, and UDI will turn on with the original factory settings.

Using the Dive Computer

The dive computer display contains a current and maximum depth indicator, a battery indicator, compass, surface interval time (SIT), and fly time displays as well as additional parameters, depending on the dive characteristics.

The dive computer display is the normal display mode that you use while diving.

From the dive computer, you can:

- Press the **Up** button to review your **RGBM** setup.
- Press the **Down** button to review additional dive data.
- Press the **Enter** button twice to go to the **Main** menu.

The dive computer display is different when the UDI™ is on the surface, and when the UDI™ is underwater.

Surface display

On the surface, the dive computer display shows the following:

① Depth 0.0 EAN: 21 %	② Net : 2 Buddy: User 1	③ 
④ PO2: 62 Depth	⑤ SIT:-----	

1. Current Depth and EAN indicator
2. Network & Buddy indicator
3. Battery indicator
4. Oxygen toxic limit depth
5. Surface interval time

Underwater display

Underwater, computer alternates between several displays, depending on your actual dive parameters:

Dive has not reached decompression time.

Depth : 15.4	Dive Time: 25 
Dmax: 32.0	Surf Time: 15
124°	No Deco: 4

Dive has not reached decompression time – Press the **Enter** button once to see this display. The display stays on for 7 seconds and then returns to the original display.

Depth: 15.4	Dive Time: 25 
Dmax: 32.0	Surf Time: 15
Safedepth: 22	SafeTime: 12

Dive has reached decompression time.

Current Depth: 33.4	Dive Time: 25 
MAX Depth: 37.0	Time to surface: 15
Ceiling: 22	Deco Time: 12

Dive has reached decompression time – Hold the **Enter** button for 5 seconds to see this display.

Current Depth: 33.4	Dive Time: 25 
MAX Depth: 37.0	Time to surface: 15
Dsafe: 12	Safe Time: 6

A ▲ or ▼ displays in the bottom left quadrant, accompanied by a tone to inform you to go up or down when you overstep the bounds of decompression or safe diving time.

Dive computer parameters

- **Battery Indicator** – Battery energy level.
- **Buddy** – Name of buddy who will receive messages by default.
- **Ceiling** – Ceiling height for **Decompression stop**. The minimum depth allowed while in decompression stop, in steps of 3 meters.
- **Deco time** – Decompression time in minutes.
- **Depth** - Current Depth indicator – Indicates current depth.
- **Dive time** – Duration of current dive, in minutes.
- **Safe** – Indicates **Safety stop** dept, between 3 - 6 meters.
- **Stop** – Indicates **Deep stop** depth in a layer of 3 meters below the Deep stop.
- **EAN** – Enriched Air Nitrox – indicates mixture percentage.
- **Fly Time** – The minimum time required prior to flying (in Hours format HH:MM).
- **Heading** – Heading direction in degrees from north.
- **Mdepth** – Maximum depth achieved in current dive.
- **Net** – Network used for communications.
- **No Deco** – The remaining time before getting into decompression situation, at the depth shown (in minutes).
- **PO2 Depth** – Maximum depth allowed before Oxygen toxicity related to the PPO2 pressure between 1.4 to 1.6 Atm.
- **Safe time** – Safety stop time. Down counter from 3 minutes to zero.
- **SIT** – Surface Interval Time - Counting the time the diver is out of the water to be calculated till the next repetitive dive. When reaching to 24 hours, the dive computer will start a new dive session (no Nitrogen residues).
- **Surf Time** – The minimum expected time to the surface, taking in account all needed stops, in minutes.

Reviewing RGBM setup and viewing additional data

While in Dive Computer mode, you can:

- Press the **Up** button to see your tissue saturation graph.
- When none of the tissues are above 100% - you are not in a deco situation according to the UDI™

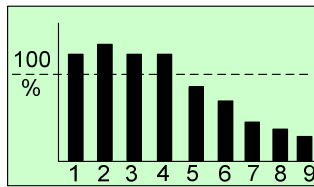

- Press the **Up** button again to review your RGBM setup options.

RGBM SETUP	
S/N: 99999999	
Salt	Water
Altitude:	0-700m
EAN	21-Air

- Press the **Up** button again to review the second page of the RGBM setup options.
- Press the **Up** button one more time or press the **Enter** button at any time to return to Dive computer mode.

RGBM SETUP	
Model:	Model 2
O2 Max Depth:	61m
Deep Stop:	Disable

On the surface:

- Press the **Down** button see the compass.
- Press the **Down** button again to review dive parameters.

Last Dive Parameters	
SIT: _____	Tdive: 26
Fly: _____	Dmax: 37
Dive No. 1	Temp: 23c°

Underwater:

- Press the **Down** button see the compass.
- Press the **Down** button again to review dive parameters.
- Press the **Down** button again to review additional dive parameters.

Dive Parameters	
Total	
Deco: 237	20:15
CNS: 051	Heading: 90°
OTU: 35.1	

Dive Parameters	
	20:15
Re-Dive factor:	100%
Tem: 17°C	

Abnormal conditions

Low battery prior to a dive

If the battery status becomes empty prior to a dive, and the diver decides to dive despite this warning, the UDI™ locks the dive computer automatically for 24 hours starting at the end of the dive and will ask the diver to charge it.

depth	15.4	1	
max	32.0	dive time	
LOW BATTERY!!! Please Charge UDI			

UDI™ will continue to work as a timer and depth meter (gauge mode) only and will not calculate the decompression parameters or other diving computer parameters.



WARNING: The UDI™ may turn itself off during the dive.

Low battery during dive

When the battery contains less than 3 hours charge, UDI™ will display a warning message and sound an alert tone. Click **Enter** to return to the dive computer display.

When the battery contains less than 2 hours charge, UDI™ will display an additional warning message and sound an alert tone. Click **Enter** to return to the dive computer display.

When the battery contains less than 1 hours charge, UDI™ will display yet another warning message and sound an alert tone. Click **Enter** to return to the dive computer display.

Each transmission is shortening the battery time of operation.



WARNING: In all cases of low battery alert, start ascent immediately, according to safe diving practice, and recharge the UDI™ after you reach the surface.

Empty battery during dive

If the battery status becomes empty during a dive, the battery icon starts to flash in addition to the UDI™ sounding an alert tone. This indicates that the UDI™ can continue to work for a half hour with 1 transmission every 4 minutes.

depth	15.4	25	
max	32.0	dive time	
124°		24	No deco



WARNING: Start ascent immediately, according to safe diving practice, and recharge the UDI™ after you reach the surface.

Fast ascent

The maximum ascent rate is limited to 10 meters (33 feet) per minute.

In case of violation, the UDI™ will sound an alert, and flash **SLOW** in the display in the center of the screen.

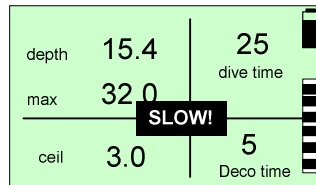

Use the *ascent bar* below the battery indicator to guide your ascent. Maximum ascent rate allowed is reached when the bar is full.



NOTE: A fast ascent can affect the calculations for subsequent dives. In these cases, subsequent dives will be calculated using more conservative factors.

Safety stop and Deco stop violation

In case the diver over steps the minimum ceiling depth of the deco stop or the minimum depth of the safety stop, the UDI™ sounds an alert tone and displays an arrow that points down.

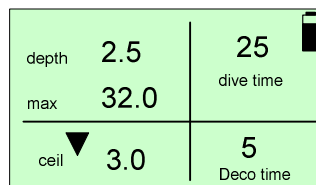

Severe decompression violation

If the diver violates the decompression stop for at least 1 minute, or is out of bounds by at least 2 meters (6.5 feet) from the decompression depth, **the UDI™ locks the dive computer and continue only as a timer and depth meter.**

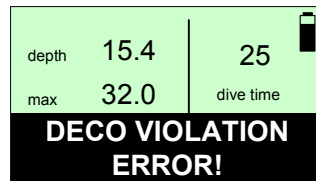

WARNING: In case of severe decompression violation, UDI™ will stay locked for the next 48 hours after the end of the dive.

Using the Compass

The electronic compass display can be used to navigate and orient yourself underwater. This compass is accurate within $\pm 2^\circ$ from the magnetic North.

The electronic compass accuracy is influenced by the presence nearby metal bodies and may be biased dramatically.

See *Care and maintenance* on page 39 for information on periodic recalibration of the electronic compass.

To see the compass display:

- From the **Main** menu, select **Compass**.

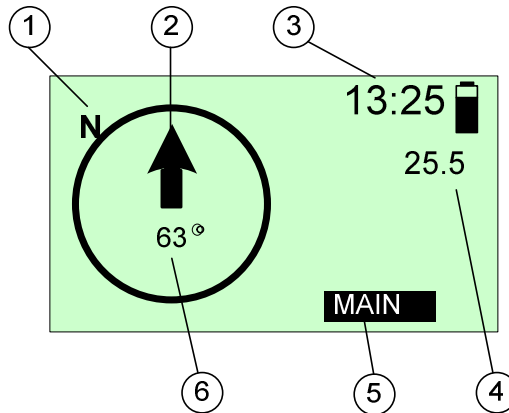

- 1. Magnetic North
- 2. Heading direction
- 3. Time
- 4. Depth
- 5 Back to Main menu
- 6 Your heading (Degrees)

To exit the compass display:

- Select **Main** and click **Enter**.

Sending and receiving text messages

Messages are pre-set using the PC connection and UDI™ software. To modify the pre-set message list, see page 58.

You can send messages to your buddy or other UDI™ users on the same network using the **Send Message** function.

To enter the Message menu:

- From the **Main** menu, select **Messages** and press **Enter**.

To exit the **Messages** menu and return to the **Main** menu, select **Main**, and press **Enter**.

Sending a message

The UDI™ unit can sent one of the 14 user-preset text messages to other UDI™ users.

To send a text message:

1. In the **Messages** menu, select **New Message**, then click **Enter**.
2. In the Message list, choose a message by scrolling with the **Up/Down** buttons. Click **Enter**.

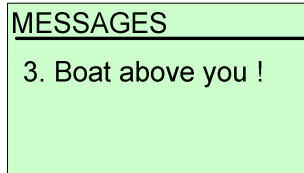
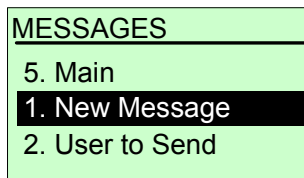

- In the **Messages** menu, **User to Send** is selected.
Click **Enter**

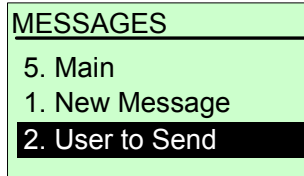

- In the **Send To** menu, choose a user by scrolling with the **Up/Down** buttons.
Click **Enter**.

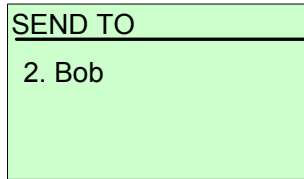

- In the **Messages** menu, **Send** is selected.

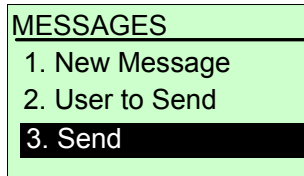

- Click **Enter**. The message is sent. You are automatically returned to the **Main** menu.

Viewing last message

- In the Messages menu, select **Last Msg Rcv**,
- Click **Enter**. The last message received is shown, and identifies the sender and network used.
- Use the **Up/Down** buttons to scroll the last five messages received.

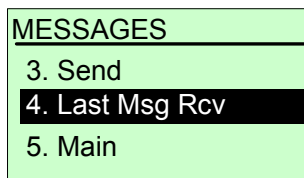

Receiving a message

When you receive a text message from your buddy or another UDI™ user, your UDI™ unit sounds an audible signal and blinking light (if enabled), and the message is automatically displayed.

The received message identifies the message sender.

Only if the message is an SOS:

The depth of the diver sending the message is also displayed in the message.

In the example on the right, the sender is Brad, at a depth of 8.3 meters.

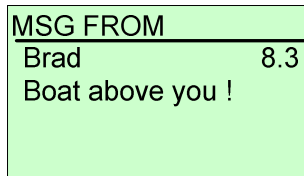

Click **Enter** to turn off the audible signal and automatically transmit an acknowledgement signal to the sender. After a short while, the UDI™ return to the dive computer display.

Navigation to a target

UDI™ can be used to track an SOS beacon or a Homing beacon.

A homing beacon transmits a homing signal from the boat unit on a specific dedicated frequency. An SOS beacon transmits a homing signal on a specific frequency, received on all networks used with UDI.

Navigation using the UDI™ can be done only while the diver or beacon are moving in relation to each other. In other words, the UDI™ diver, the beacon, or both must be moving, since the navigation beacon relies on the Doppler Effect.

UDI™ can use one of two different navigation methods for tracking:

- **One step** – corrects navigation as you dive showing the adjusted direction of the target beacon on the UDI. Choose a random initial direction to start diving, then adjust as you go. This is the UTC-recommended navigation method. This is the recommended method to be used by most divers.
- **Two steps** – recommended for use by experienced divers only. This method requires you to dive 1 ½ times around a circle (1 to 2 meters (3 to 6 feet) in diameter) while using a point of reference prior to showing you the direction of the target beacon on the UDI.

The differences in the two methods are illustrated below.

One-Step method (Recommended)

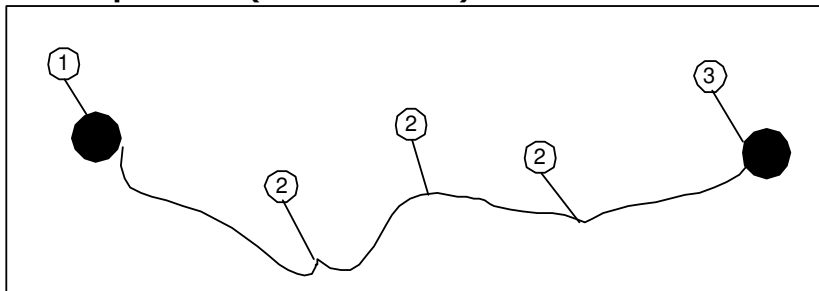

1. Starting location of diver
2. Course adjustments
3. Beacon location

Two-Steps method

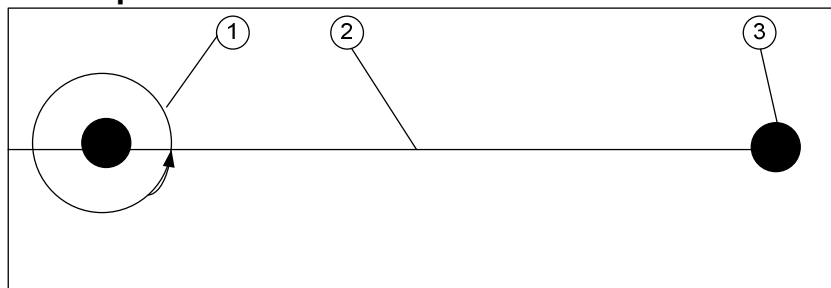

1. Starting location of diver -
Circle a point of reference 1 ½ times to acquire vector
2. Course/Azimuth vector
3. Beacon location

To enter Navigation mode:

- From the UDI™ **Main** menu, select **Navigation** and press **Enter**.

To exit the **Setup** menu and return to the **Main** menu, select **Main**, and press **Enter**.

Navigation mode and method

Navigation is used to dive to a homing beacon, or to a unit transmitting an SOS signal to provide assistance.

You must select the tracking mode and the tracking method to use the UDI™ Navigation feature.

1. From the **Navigation** menu, select **SOS track** to track an SOS beacon, or **Homing track** to track a Homing beacon.

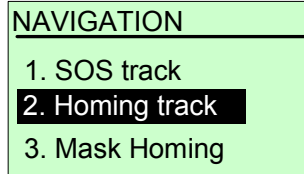

2. Press **Enter**.
3. Select **One Step** method or **Two Step** method and press **Enter**.

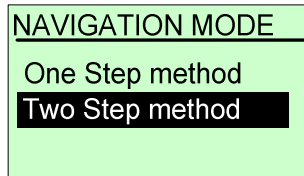

4. The **Navigation** display opens.
(The example shown here is for Two step navigation)

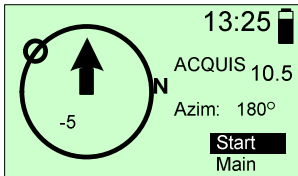

Using the Navigation display

In the **One Step** method, the display shows the **track to your target**. Keep an eye on the track to navigate to your target. You should dive in a slight zigzag direction to allow for more accurate navigation towards your target.

In the **Two Steps** method, swim 1 ½ times around a fixed location to allow the UDI™ to **acquire a course**. Once the course is acquired, keep an eye on the **beacon relative direction** to make sure that you are not swimming away from your target.

The navigation display for one step navigation is explained below.

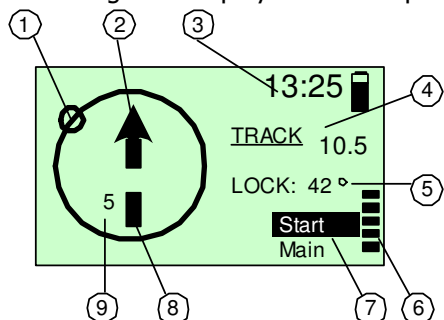

1. Beacon direction (relative to your heading). Will appear in the first time only if the Doppler value (see 9.) is greater or equal 4).
2. Swim direction (your heading)
3. Time
4. Track – current track direction
5. Lock – the course you need to follow to arrive at the beacon

6. Ascent bar – shows you the limits of your ascent rate
7. Start – restart tracking. This is useful if you suddenly loose the beacon
8. Doppler value bar – shows that you are approaching (getting closer to) the target.
9. Doppler value - shows how quickly you are approaching (positive numbers) or moving away (negative numbers) from the target

The navigation display for two step navigation is explained below.

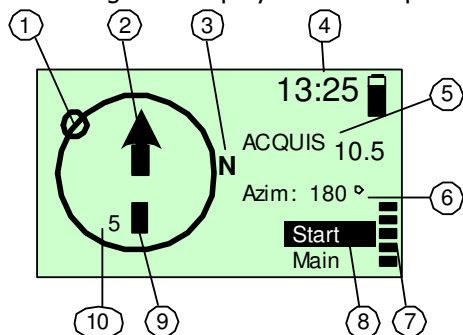

1. Beacon direction (relative to your heading) – will appear ONLY after the first step is successfully over, Will appear in the first time only if the Doppler value (see 9.) is greater or equal 4).
2. Swim direction (your heading)
3. North
4. Time
5. Acquis – current track step. Will be changes to TRACK after the first step is successfully finished
6. Azim – Azimuth/Course direction to beacon (degrees from North)

7. Ascent bar – shows you the limits of your ascent rate
8. Start – restart tracking. This is useful if you suddenly loose the beacon.
9. Doppler value bar – shows that you are approaching (getting closer to) the target.
10. Doppler value - shows how quickly you are approaching (positive numbers) or moving away (negative numbers) from the target

SOS Signals

Unlike other UDI™ signals, SOS signals are activated across all network channels, and have a longer range than ordinary communications signals.

In the event of an emergency, you can activate your SOS signal by pressing the red H (Help) button on your UDI™ for several seconds. An SOS signal is sent to all UDI™ users in the area.

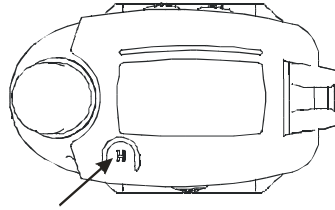

EMERGENCY (HELP) BUTTON

Other UDI™ users can then home in and navigate to your location using the Navigation feature of their units.

If you receive an SOS signal, your UDI™ unit sounds an audible signal, and the SOS message is automatically displayed.

The SOS message identifies the user sending the SOS, the network, and the depth of the sender.

In the example on the right, the sender is User 1, at a depth of 32 meters.

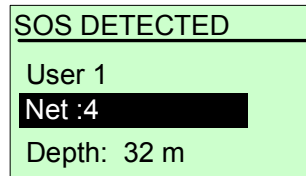

Click **Enter** to turn off the audible signal. UDI™ displays the Navigation Mode screen.

Navigate to the diver in distress using one of the methods described on page 34.

Remote homing

UDI™ contains the ability to send a remote homing signal to the boat unit.

The remote homing signal takes the form of a message that cannot be modified or deleted from the message list.

To activate the remote homing or remote SOS:

1. In the **Message** menu, select Remote Homing from the list by scrolling with the **Up/Down** buttons, then click **Enter**.
2. Click **Send**. The message is sent

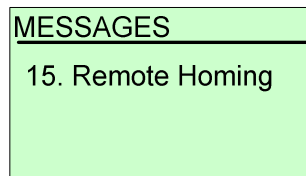

Remote SOS

UDI™ contains the ability to send a remote SOS signal to another user.

Failure to respond and cancel the request by the user receiving a remote SOS causes the UDI™ to start sending SOS signal to the entire network. You will receive an SOS signal and navigate to the diver in distress using one of the methods described on page 34.

The remote SOS signal takes the form of a message that cannot be modified or deleted from the message list.

To activate the remote SOS:

1. In the **Message** menu, select Remote SOS from the list by scrolling with the **Up/Down** buttons, then click **Enter**.
2. Click **Send**. The message is sent

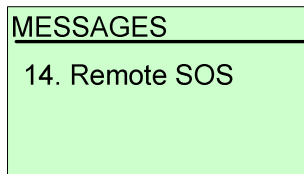

Mask Homing

You can temporarily mask the navigation homing beacon to prevent your UDI™ from sounding a homing alarm when a homing signal is transmitted. This allows you temporarily disregard the homing signal until the time you need it to return to the boat station.



NOTE: Masking the homing beacon *does not* mask any SOS beacons that may be activated during a dive.

To mask a homing beacon:

1. From the **Navigation** menu, select **Mask Homing** and press **Enter**.
2. In the **Mask Homing** menu, select **Enable** to mask the beacon and press **Enter**.

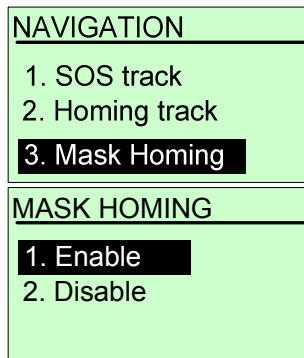

When you enable **Mask Homing**, a small **M** is shown in the lower right corner of the LCD display.

Care and maintenance

UDI™ requires very little care or maintenance.

After every dive: wash and wipe down the UDI™ and make sure that the contacts are dry prior to confectioning the UDI™ to the charger or the PC.

Do not use a water jet or pressure from hose to clean the UDI, to prevent damage to the UDI™ mechanism.

Periodically the UDI™ may need to be serviced at an authorized laboratory for calibration and battery replacement. Consult the UDI™ webpage for information.

The UDI™ display protective sticker may get scratched and can be replaced. The UDI™ can be removed from its housing for display housing replacement as shown in the diagram below.

Remove the cover by unscrewing the tops from the two hinge screws, and pulling the hinges out of the housing. This frees the housing and allows you to remove it from the UDI™ unit. You can then pop the protective cover out, and replace it with a new cover.

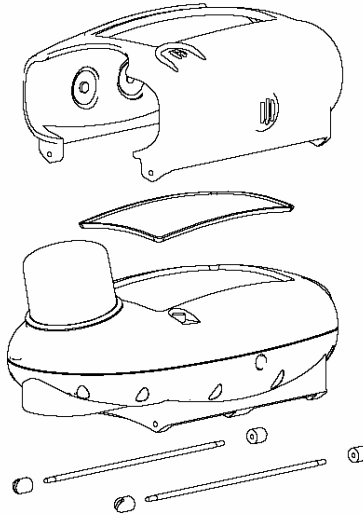

Revert to factory setting

In case you need to revert to the original UDI factory settings, press the **Up**, **Down** and **Enter** buttons simultaneously (when the UDI™ is off). Wait for the UDI to turn on.

All customizations and settings you have done will be erased, and UDI will turn on with the original factory settings.

Base [boat] unit

The boat unit is an optional component of the UDI™ system. It is used for text message communication with the underwater divers, and its homing capabilities allow divers to navigate their way back to the boat.

The boat unit is shown below:

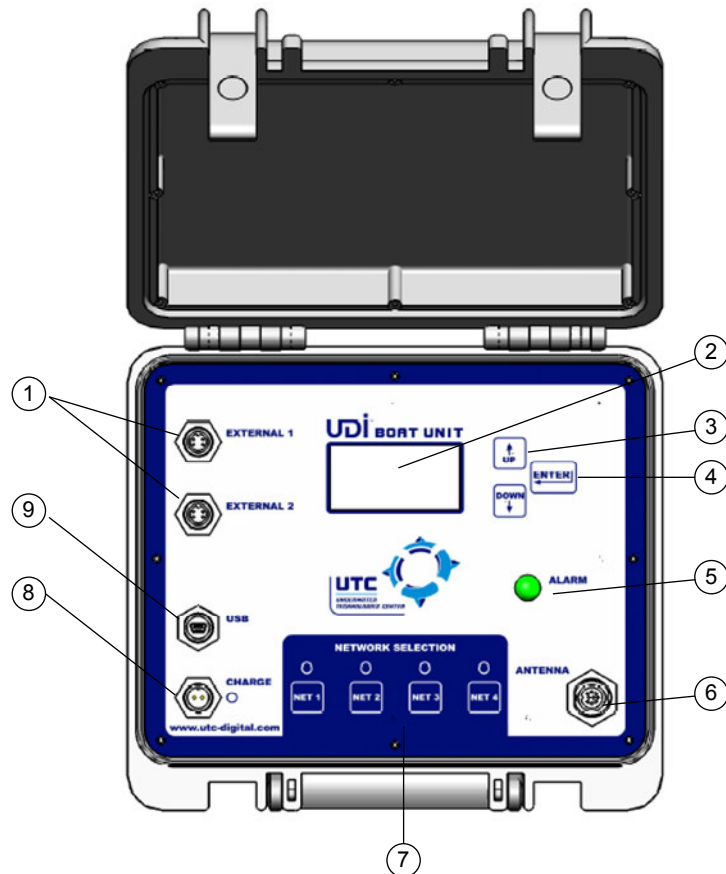

- | | |
|--|---|
| 1. External connectors (for siren and light) | 5. Alarm light |
| 2. LCD display, glass protector | 6. Antenna connector |
| 3. Up and Down scroll buttons | 7. Network selection buttons and lights |
| 4. Enter button | 8. Power charge connector |
| | 9. USB connector |

The boat unit Antenna is shown below:

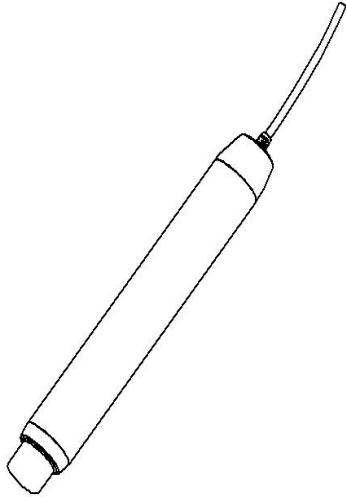

The UDI™ boat unit contains the following functions:

- Electronic compass
- Message sending/receiving
- Homing beacon
- Dive logger

Use of these functions is explained below.

Charging the UDI™ boat unit

UDI™ uses a rechargeable internal battery. You can use the boat unit running on a battery, or connected to a power supply.

Connect the power adapter to the power connector on the UDI™ boat unit to recharge the battery or to use the unit.



NOTE: Read *Lithium Polymer Charging, Handling, Safety Information* on page 4.



WARNING: The UDI™ boat unit is a completely sealed unit. It may stop functioning if opened. The warranty will be void if the unit is disassembled or the seal is broken.

Connecting the UDI™ boat unit to the PC

You can connect the UDI™ boat unit to the PC to perform data transfers (messages table, users table), using the DiveSim application. (See page 50 for information on using DiveSim).

To connect the UDI™ boat unit to the PC:

Connect the USB cable to the computer.



NOTE: Ensure that you have properly installed the DiveSim™ software to be able to use this function.

Turning UDI™ boat unit On and Off

To turn the UDI™ boat unit on:

1. Press and hold the **Enter** button for about 4 seconds. The UTC Proprietary screen opens, the buzzer is heard and the LED is blinking.
2. Press the **Enter** button again. The current settings screen opens.
3. Press the **Enter** button again. The setup menu opens. After a few seconds, the dive computer displays.

To turn UDI™ boat unit off:

Press and hold the **Enter** button for about 4 seconds. The UDI™ turns off.

Scrolling the menus

To scroll through the menu options, press the **Up** or **Down** buttons.

To select an option, press the **Enter** button.

UDI™ Boat unit main menu

The main UDI™ menu allows you to access UDI™ functions. The main menu flowchart is shown below.

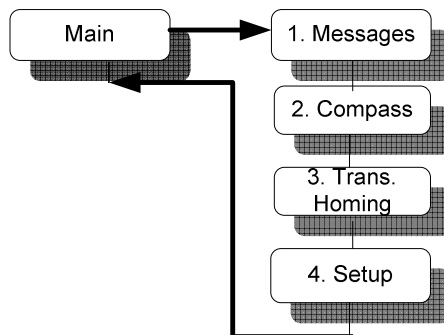

The various functions are described in detail as follows:

- Messages – see page 42
- Compass – see page 44
- Transmit homing – see page 45
- Setup – see page 46

Sending and receiving text messages

Messages are pre-set using the PC connection and UDI™ software. To modify the pre-set message list, see page 58.

You can send messages to UDI™ users on the same network using the **Send Message** function.



NOTE: Each network contains its own list of users and of preset text messages.

Messages and users can be updated using the PC connection for the active network only.

To enter the Message menu:

- From the **Main** menu, select **Messages** and press **Enter**.

To exit the **Messages** menu and return to the **Main** menu, select **Main**, and press **Enter**.

Sending a message

The UDI™ unit can sent one of the 13 preset text messages to other UDI™ users.

To send a text message:

1. In the **Messages** menu, select **New Message**, then click **Enter**.

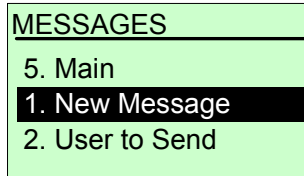

2. In the Message list, choose a message by scrolling with the **Up/Down** buttons. Click **Enter**.

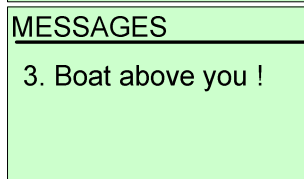

3. In the **Messages** menu, **User to Send** is selected. Click **Enter**.

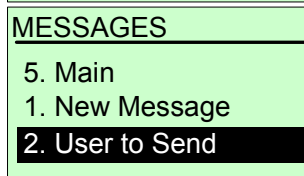

4. In the **Send To** menu, choose a user by scrolling with the **Up/Down** buttons. Click **Enter**.

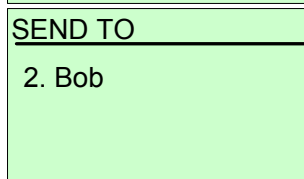

5. In the **Messages** menu, **Send** is selected.

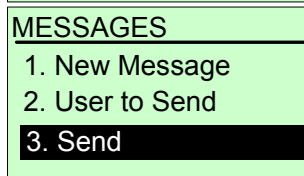

6. Click **Enter**. The message is sent. You are automatically returned to the **Main** menu.

Viewing last message

1. In the **Messages** menu, select **Last Msg Rcv**,
 1. Click **Enter**. The last message received is shown, and identifies the sender and network used.
2. Use the **Up/Down** buttons to scroll the last five messages received.

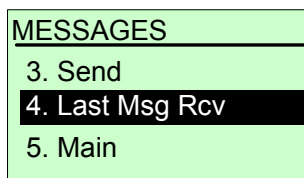

Receiving a message

When you receive a text message from another UDI™ user, your UDI™ unit sounds an audible signal, and the message is automatically displayed.

The received message identifies the message sender and the network on which it was sent.

Only if the message an SOS:

The depth of the diver sending the message is also displayed in the message.

In the example on the right, the sender is Brad, at a depth of 8.3 meters.

MSG FROM	
Brad	8.3
Coming back to boat	

Click **Enter** to turn off the audible signal and return to the dive computer display.

Using the Compass

The UDI™ boat unit contains an electronic compass display. This compass is accurate within $\pm 2^\circ$. The electronic compass accuracy is influenced by the presence nearby metal bodies and may be biased dramatically.

To open the compass display:

- From the **Main** menu, select **Compass**.

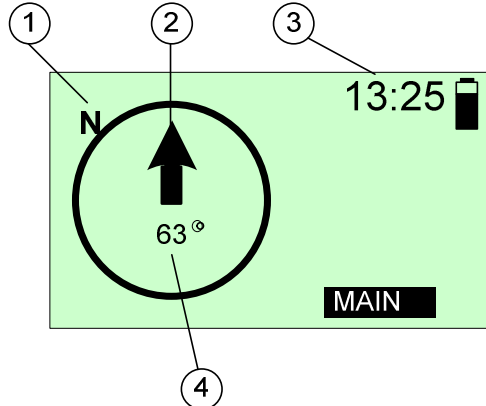

1. Magnetic North
2. Swim direction

3. Time
4. Your heading (Degrees)

To exit the compass display:

- Select **Main** and click **Enter**.

SOS Signals

Unlike other UDI™ signals, SOS signals are activated across all network channels, and have a longer range than ordinary communications signals.

If you receive an SOS signal, your UDI™ boat unit sounds an audible signal, and the SOS message is automatically displayed.

The SOS message identifies the user sending the SOS, the network, and the depth of the sender.

In the example on the right, the sender is Brad, at a depth of 32 meters.

Click **Enter** to turn off the audible signal.

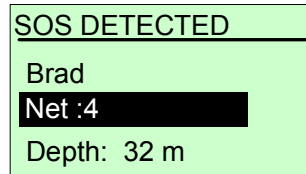

SOS DETECTED
Brad
Net :4
Depth: 32 m

Remote homing/Remote SOS

The boat unit contains the ability to send a remote SOS signal to a UDI™ user.

Failure to respond and cancel the request by the user receiving a remote SOS causes the receiving user UDI™ to start sending SOS transmit the signal.

To activate the remote SOS:

In the **Message** menu, select Remote SOS or Remote Homing from the list by scrolling with the **Up/Down** buttons, then click **Enter**.

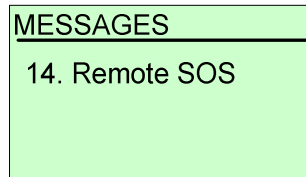

MESSAGES
14. Remote SOS

Click **Send**. The message is sent

Setting up the UDI Boat Unit

Use the Setup menu to set up the UDI Boat Unit for the following features:

- PC Connection – Connect to a PC for use with the DiveSim software
- List Sync. – Synchronize message lists with other UDI™ units (*see DiveSim™ software page 50 for details*)
- UDI™ – Set UDI™ parameters – clock, audio, light.

The Setup menu flowchart is shown below.

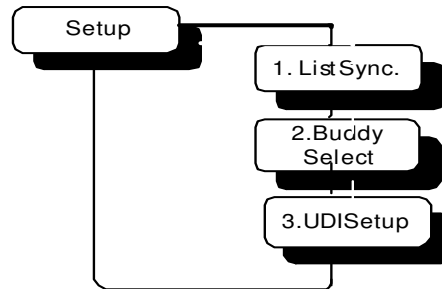

To enter the Setup menu:

1. From the **Main** menu, use the **Up/Down** buttons to scroll to Setup.
2. Press **Enter**.

To exit the **Setup** menu and return to the **Main** menu, select **Main**, and press **Enter**.

List Sync

Use this option to synchronize the user list and message list with other UDI™ users. Messages and users can be synchronized for the active network only.

If you want to update the list for the all 4 networks, you have to repeat this action, after selecting the network before performing additional synchronization.

Note that the default Buddy selection is performed for the active network at the time of synchronization

1. Place the UDI™ units next to each other so that the individual UDI™ unit antennas are touching the boat unit antenna.
2. In the Setup menu of each unit, select **List Sync** and press **Enter**.

3. Select **UDI™ Status** and press **Enter**. The UDI™ Status menu opens.

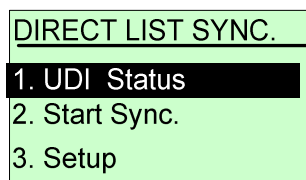

4. Select whether your UDI™ will be sending synch data or receiving synch data and press **Enter**.

Set the receiving UDI™ unit(s) to **Receiving** prior to setting the sending unit to **Sending**.

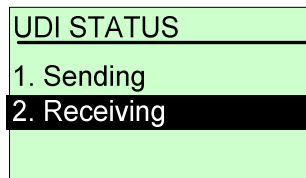

5. In the Direct List Sync. menu, select **Start Sync.** to start the synchronization process.
6. Press **Enter**. The display shows **Updating...**
7. When the update is complete, the display reverts to the **Direct List Sync** menu.

If from some reason the process was not successful – it will automatically repeat the process till the receiving unit is showing **Copy Succeed**

UDI Boat unit setup

Use the UDI™ Setup menu options to set the time, ring volume, and backlight duration on the UDI™ boat unit.

Clock

Use this option to set the time and date.

1. Select a time unit.
2. Use the **Up/Down** buttons to set the appropriate value.
3. Press **Enter** to move to the next time unit on the list.
4. Repeat.
5. When you have set the year value, press **Enter** to return to the **UDI™ Setup** menu.

CLOCK SETUP	
Minute:	11
Hour:	16
Date:	3
Month:	8
Year:	2007

Audio

Use this option to select an audio alert volume. Audio alerts sound to get your attention. There are four levels of alert:

- High
- Med-High
- Med
- Low

Select a ring volume and press **Enter**

AUDIO	
1 High	
2 Med-High	
3 Med	

An external siren and flashing light can also be connected to the unit external connectors.

Backlight

Use this option to select the time until the unit backlight turns off. Shutoff interval ranges from 0 (off) to 55 seconds, in 5-second intervals, and INF (infinite) when the backlight remains constantly lit.



NOTE: Extended use of the light may reduce battery time between charges.

Use the **Up/Down** buttons to define a time value and press **Enter**.

BACKLIGHT TIMER	
Timer -	10 sec.

LED Control

Use this option to define the **Alarm LED** light intensity. In day time – you may want higher intensity than in the night. The default value is 50% intensity.

LCD Contrast

Use this option to select a contrast level for the LCD display. . The contrast interval ranges from 1 (very little contrast) to 7 (high contrast).

Use the **Up/Down** buttons to define a contrast value and press **Enter**. Make sure there are no strips seen on the screen.

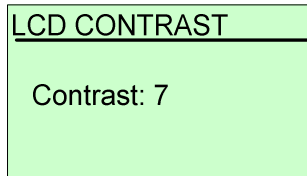

Units

Use this option to select Metric units (meters, degrees C) or Imperial units (Feet, degrees F) as your unit of measurement.

Select Imperial or Metric and press **Enter**. All units displayed on the UDI™ will now conform to the unit type chosen.

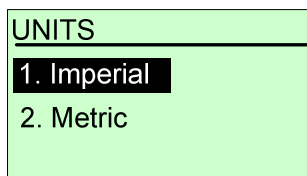

NOTE: The temperature displays according to your units selection – When you select Feet, Fahrenheit degrees are shown, when you select Meters, centigrade degrees are shown.

About UDI

Use this option to view the UDI™ serial number and software version installed. Use this information when contacting UTC about your UDI Boat unit.

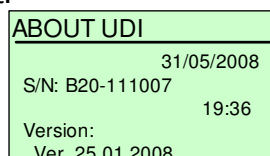

Care and maintenance

The UDI™ boat unit requires very little care or maintenance.

After every dive: wash the antenna and antenna cable. Wipe down the UDI™ boat unit and make sure that the connectors are well covered (using caps) and are dry prior to connecting the UDI™ to the charger or the PC.

Do not use a water jet or pressure from hose to clean the UDI, to prevent damage to the UDI™ mechanism.

Periodically the UDI™ boat unit may need to be serviced at an authorized laboratory for calibration and battery replacement. Consult the UDI™ webpage for information.

Revert to factory setting:

In case you would like to revert to the original UDI™ factory settings, press the **Up**, **Down** and **Enter** buttons simultaneously. Wait for the UDI to turn on and for the message "set default" appears on the screen. All customizations and settings you have done will be erased, and UDI will turn on with the original factory settings.

DiveSim™ software

DiveSim is software designed to work with your UDI™ to perform the following actions:

- Update your UDI™ message and user lists
- Manage UDI™ log
- Database management
- Dive Simulator using the PC only
- Dive Simulator using the UDI™ and DiveSim
- Upgrading the UDI (or Boat unit) Firmware

Using the software

Download the most updated version from UTCs web site at : www.utc-digital.com under Support , Download.

Save the Zip file on your desktop.

Un-zip the file and extract it to you Desktop (one single set file will be created).

Start the installation file, making sure the UDI is NOT connected to the PC, or the Quick Connect device.

At the end of the installation process, a DiveSim shortcut appears on your desktop.

Also – under the group “Underwater Technologies Center” (under programs), you will find the Instructions manual etc.

Open DiveSim by double-clicking on the **DiveSim** shortcut.

DiveSim opens in the **PC Simulator** window:



1. Menu selection
2. About DiveSim

5. Tissue saturation graph
6. Diving configuration panel

- 3. UDI™ connection status
- 4. Metric/Imperial unit toggle
- 7. Dive computer display panel
- 8. Dive depth graph

When connecting the UDI to the PC (using the Quick Connector and the USB cable, making sure the UDI is the to “PC Connection” enable, there is an automatic check for possible Firmware (internal UDI software) newer version. If the is such version – you well be offered to upgrade.

UTC is strongly recommends to always use the most updated version.

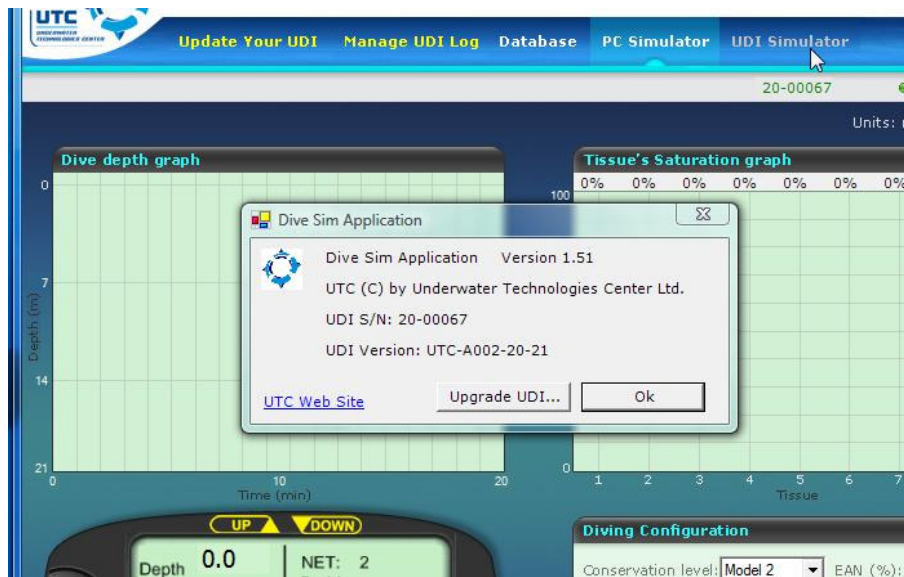

In order to make such upgrade possible, you have to download the most recent available software from UTC web site (www.utc-digital.com), at the specific location: <http://www.utc-digital.com/downloads.asp?cid=106&pr=39> .

After downloading the file from the web site, save it on your desktop. Un-zip the file (to you desktop). Run the unzipped file and the most updated DiveSim software as well as the most updated UDI software will be available to you.

You can always initiate the upgrading process by going into the “about DiveSim” button on the upper right corner of the screen.

The menu selection bar contains the following options:

- Update your UDI™ – manage and update your UDI™ user lists and list of messages (see page 57)
- Manage UDI™ log - manage and save dives log data from your UDI™ to the PC (see page 55)
- Database - load and maintain dive-data information on the PC (see page 54)
- PC Simulator - perform a dive simulation without connecting the UDI™ to the computer (see page 52)

- UDI™ Simulator - perform a dive simulation by connecting the UDI™ to the computer (see page 53).

Use and functions for each of these options is described below.

PC Simulator

The PC Simulator function is used to perform a dive simulation without connecting the UDI™ to the computer.

The PC Simulator **Dive depth graph** shows the dive profile over time. In a dive simulation, the dive-depth profile updates twenty times faster than real-time.

The **Tissue saturation graph** updates as a function of the dive depth profile and is calculated at the speed of the dive simulation.

The **Dive configuration panel** is used to adjust the dive parameters on the simulator as they are also defined in the RGBM dive computer.

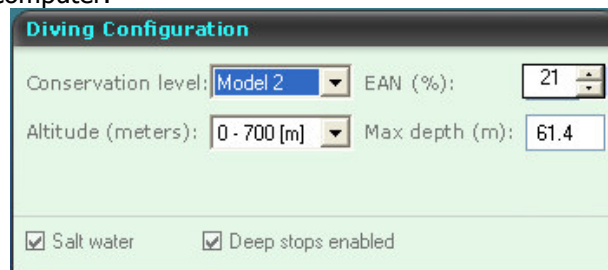

It contains the following:

- **Conservatism level** – select from one of the 5 available levels (see RGBM Model on page 19)
- **Altitude** – select an altitude level for your dive location (see Altitude on page 19)
- **EAN** – define Nitrox percentage (see Nitrox on page 19)
- **Max depth** – insert maximum depth as if you are using in a dive plan, to determine the PO₂ limit.
- **Salt water** – check if this is a salt water dive simulation
- **Deep stops enabled** – check to allow this option.

The **Dive computer display** panel contains dive the computer data shown in the UDI™ dive computer display (see *Using the Dive Computer* on page 27).

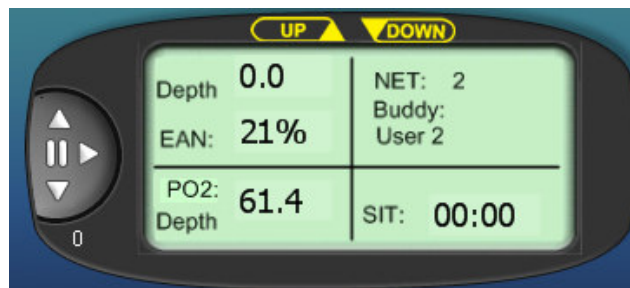

The top of the Dive computer display contains the Up and Down buttons that serve a similar function to the Up and Down buttons on the UDI™ unit.

- Click the **Up** button to see the RGBM setup parameters.
- Click the **Down** button to see the last diver parameters.

The left side of the Dive computer display contains the simulator controls which are used to simulate a dive:

- **Up** arrow – moves the diver up
- **Down** arrow – moves the diver down
- **Forward** arrow – maintains the diver at the selected depth
- **Pause** button – pauses the simulation. When paused, the button is red.

UDI™ Simulator

The UDI™ Simulator function is used to perform a dive simulation by connecting the UDI™ to the computer, and seeing the way a dive plays out on the UDI.

During a simulated dive using this function, the UDI™ reacts exactly in the same way as it would in a real dive. This allows you to test your planned dive.

The UDI™ Simulator **Dive depth graph** shows the dive profile over time. In a dive simulation, the dive-depth profile updates twenty times faster than real-time.

The **Tissue saturation graph** updates as a result of the dive depth profile and is calculated at the speed of the dive simulation. This is actually the calculation performed by a dive computer.

The **Dive configuration panel** displays the dive parameters on the simulator.

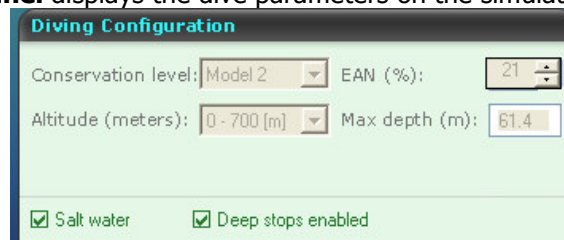

It contains the following:

- **Conservatism level** – shows one of the 5 available levels
- **Altitude** – shows the altitude level for your dive location.
- **EAN** – shows Nitrox percentage defined
- **Max depth** – shows the maximum depth, to determine the PO₂ limit.
- **Salt water** – checked if this is a salt water dive simulation
- **Deep stops enabled** – checked to allow this option.

The **Dive computer display** panel contains the computer data shown in the UDI™ dive computer display (see *Using the Dive Computer* on page 27).

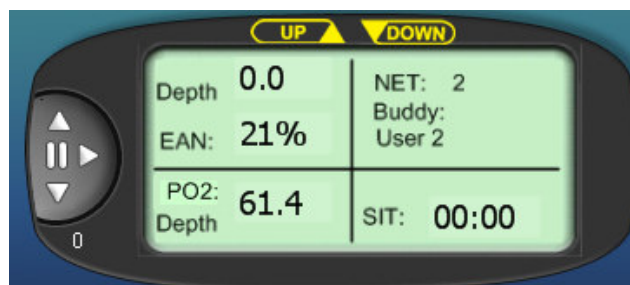

The top of the Dive computer display contains the Up and Down buttons that serve a similar function to the Up and Down buttons on the UDI™ unit.

- Click the **Up** button to see the RGBM setup parameters.
- Click the **Down** button to see the last diver parameters.

The left side of the Dive computer display contains the simulator controls which are used to simulate a dive:

- **Up** arrow – moves the diver up
- **Down** arrow – moves the diver down
- **Forward** arrow – maintains the diver at the selected depth
- **Pause** button – pauses the simulation. When paused, the button is red.

Database function

The Database function is used to load and maintain dive data information on the PC.

The database function contains 3 tabs:

- PC Simulator log
- UDI™ Simulator log
- UDI™ Logbook on PC

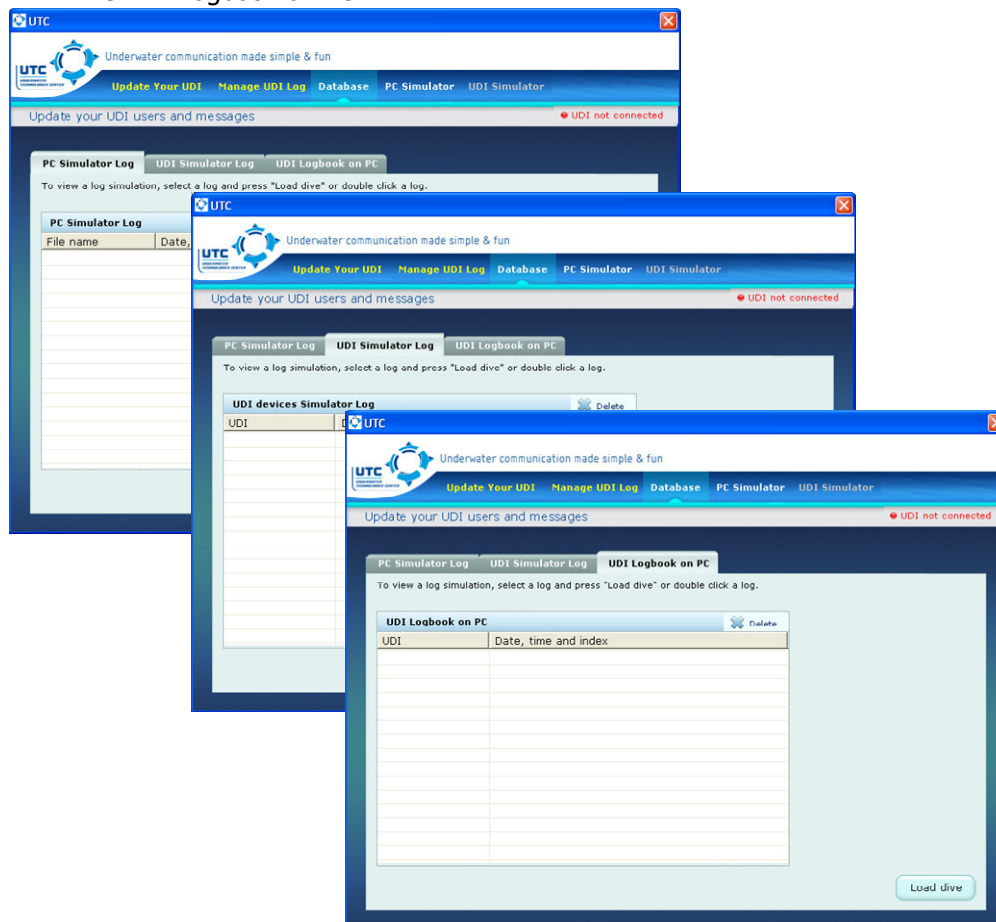

Each of these tabs contains a table with a list of Files/Devices and Time, Data and Index data.

Data can be loaded to the database using the **Load Dive** button.

A database entry can be deleted by selecting it and clicking the **x delete** button

In case that the dive was recorded in 'Gauge mode', the DiveSim's screen will show the followings:



All nine tissues will be presented as saturated which indicate that there is no information with respect to the Nitrogen.

Manage UDI™ log

The Manage UDI™ log function allows you to manage and save dive log data from your UDI™ to the PC.

To manage your UDI™ log.

1. Connect the UDI™ to the PC USB port.
2. On the UDI, select Setup > PC Connection > Enable.

The **Manage UDI™ log** window shows a list of UDI™ logged dives.

Select the wanted dives, and click **Get from UDI™** to save them to the PC.

Select the wanted dives, and click **Erase** to erase them to the UDI.

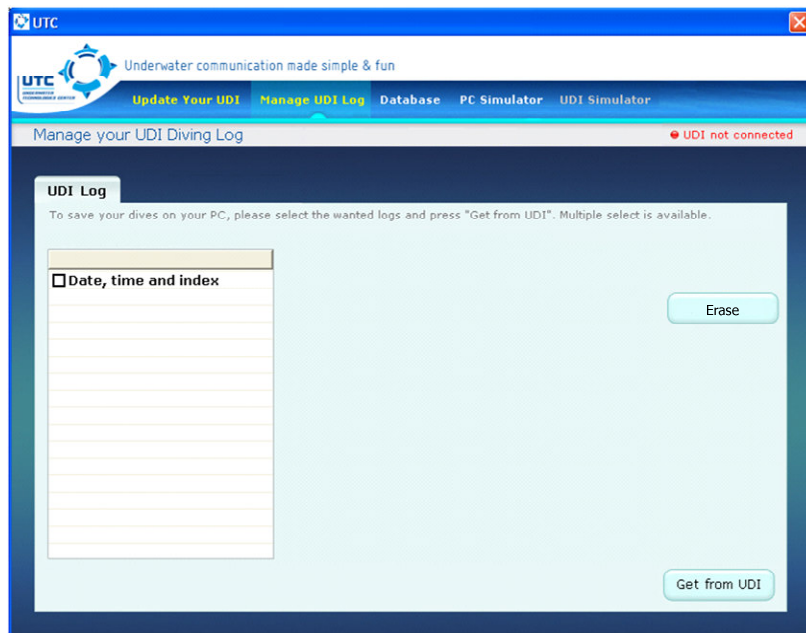

Update your UDI

The **Update your UDI™** function is used to manage and update your UDI™ user lists and list of messages.

To modify you list of UDI™ users

1. Click **Update your UDI**, and click the Your UDI™ Users tab.

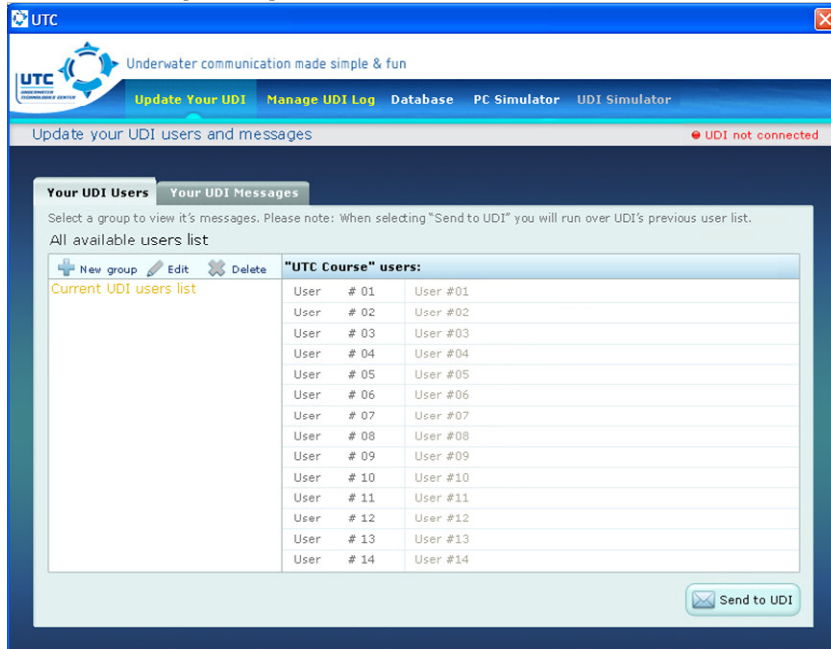

2. You can:

- Click **New group** to create a new group of users
- Select an existing group, and click **Edit** to edit the user list.
- Select an existing group and click **Delete** to remove the group.

When you create or edit a group of users, the **Edit Users** list appears.

- Place your cursor in the entry box, and type the name of a new user.
- Click **Clear** to delete the name of a user.
- Click **Save** when you have finished editing the list. The list appears on the right side of the **Your UDI™ Users** tab and is saved on your PC.

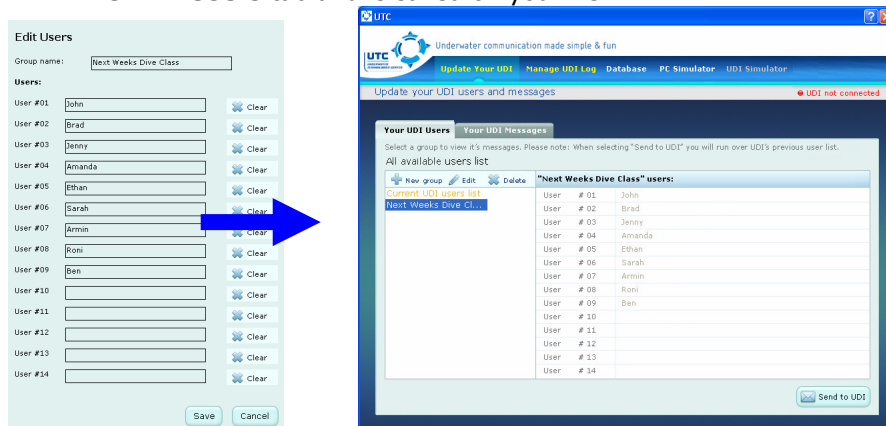



NOTE: The update is done on both user and messages tables simultaneously. Therefore, you should finish editing both tables prior to performing the update.

To send a list of users to your UDI:

2. In the UDI™ menu, select **Setup > PC Connection > Enable**.
3. Verify that the UDI™ is connected to the PC by looking at the UDI™ connection status sign on the UDI™ display.
4. Click Send to UDI. The list gets sent to the UDI.
5. When the process is completed, the following message appears:

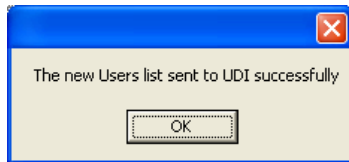

6. Click **OK** to return to the **Update your UDI™** window.

To modify your list of UDI™ Messages:

1. Click **Update your UDI**, and click the **Your UDI™ Messages** tab.

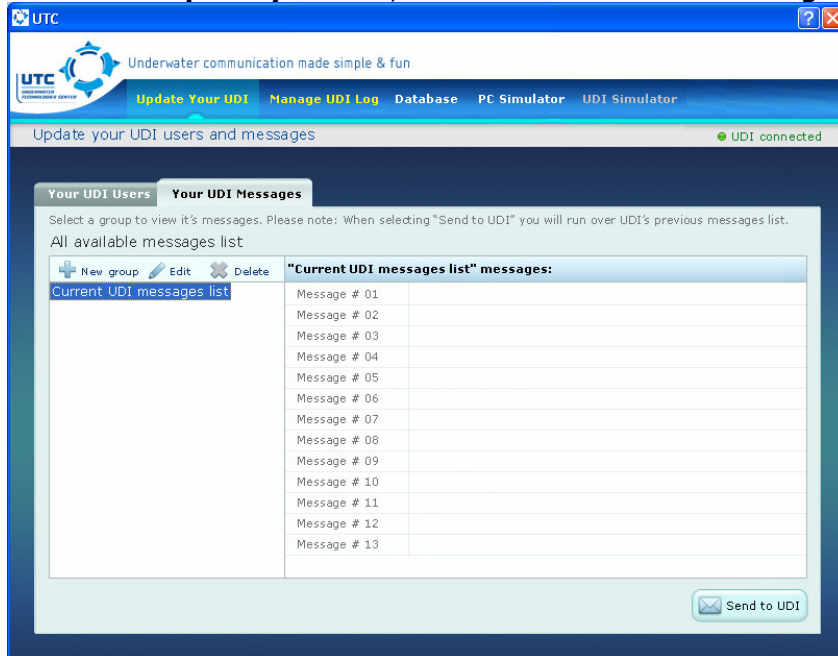

2. You can:
 - Click **New group** to create a new group of users
 - Select an existing group, and click **Edit** to edit the user list.
 - Select an existing group and click **Delete** to remove the group.

When you create or edit a group of messages, the **Edit Messages** list appears.

- Place your cursor in the entry box, and type a new message.

- Click **Clear** to delete a message.
- Click **Save** when you have finished editing the list. The list appears on the right side of the **Your UDI™ Messages** tab.

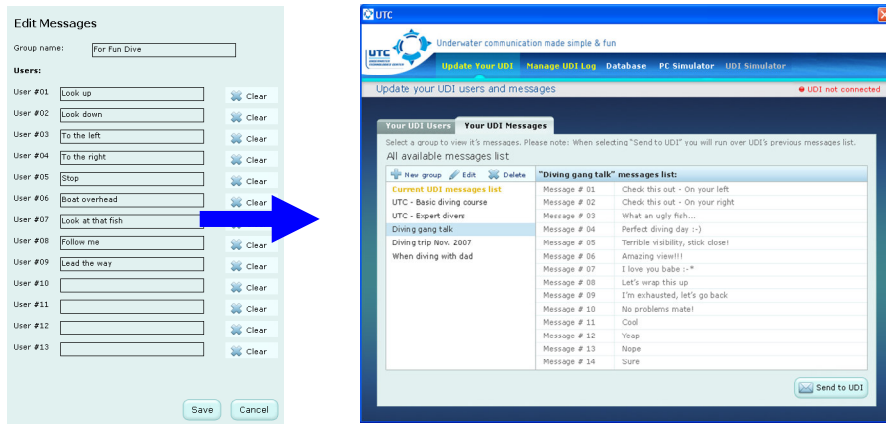

To send a list of messages to your UDI.

1. In the UDI™ menu, select **Setup > PC Connection > Enable**.
2. Verify that the UDI™ is connected to the PC by looking at the UDI™ connection status sign on the UDI™ display.
3. Click **Send to UDI**. The list gets sent to the UDI.
4. When the process is completed, the following message appears:



5. Click **OK** to return to the **Update your UDI™** window.

Appendix – RGBM Model

The **Reduced Gradient Bubble Model** is an algorithm developed by Dr. **Bruce R. Wienke** that is used to calculate the decompression stops needed for a particular dive profile. It assumes asymmetric off gassing and compensates for nitrogen microbubbles, which can reduce the rate of off gassing.

The RGBM has gained tremendous popularity in the recreational and technical diving worlds in just the past few years.

The RGBM algorithm considers various factors, including the maximum depth reached during the dive and the length of time underwater. For repetitive dives it also includes the *surface interval*, or the time spent above the water between the previous dive and the start of the current dive. This information is used to calculate the amount of residual nitrogen build-up in the diver's tissues after completing a dive.

The RGBM:

- Monitors continuous multiday diving
- Computes for closely spaced multiple dives
- Computes for a dive that is deeper than the previous one
- Adapts for rapid ascents which build up microbubbles

The algorithm provides additional safety features though its ability to be set for a variety of situations and dive profiles.

Depending on the situation, the RGBM adapts decompression data by:

- Reducing no-decompression stop dive times,
- Adding mandatory safety stops
- Increasing decompression stop times
- Increasing the surface interval

The UDI™ allows the diver to choose between the traditional recommended safety stop and deep stops. Deep stops occur deeper than traditional stops to minimize microbubble formation.

The RGBM model calculates deep stops iteratively, placing the first stop at approximately halfway between the maximum depth and the ceiling depth. After completing the first deep stops, another deep stop is set halfway to the ceiling and so on.

Personal adjustment

Divers can input personal adjustments into the RGBM decompression model. There are 5 modes to choose from. Factors which can affect which mode to choose vary between divers, and for the same diver from one day to the next. The factors which can increase susceptibility to decompression illness include, but are not limited to:

- Cold exposure
- Fitness level
- Fatigue
- Dehydration
- Previous cases of decompression illness
- Stress
- Obesity

The model should be adjusted to a conservative level, according to personal experience and ability. Under ideal conditions, use the default value of mode 2.

If conditions are more difficult, choose a more conservative model. The UDI™ adjusts the RGBM model according to the mode entered, and provides appropriate decompression times.

The UDI™ also allows more experienced divers who are willing to accept some risks to choose a lesser level of conservativeness.

Additional, in-depth information about the RGBM can be found in:

<http://www.rgbmdiving.com/index.htm>

REDUCED GRADIENT BUBBLE MODEL
WITH BASIS AND COMPARISONS
NAUI Technical Series 8
Bruce R. Wienke and Timothy R. O'Leary
<http://www.scuba-doc.com/rgbm.pdf>

REDUCED GRADIENT BUBBLE MODEL:
DIVING ALGORITHM, BASIS, AND COMPARISONS
Bruce R. Wienke and Timothy R. O'Leary
<http://www.scuba-doc.com/rgbmim.pdf>